

Foreword

Garmin International, Inc., 1200 East 151st Street, Olathe, Kansas 66062, U.S.A.

Tel: 913/397.8200

Fax: 913/397.8282

Garmin AT, Inc., 2345 Turner Rd., S.E., Salem, Oregon 97302, U.S.A.

Tel: 503/581.8101

Fax: 503/364.2138

Garmin (Europe) Ltd.

Liberty House, Bulls Copse Road, Hounslow Business Park, Southhampton, SO40 9RB, U.K.

Tel. +44 (0) 37 0850 1243

Fax +44 (0) 23 8052 4004

Garmin Singapore Pte. Ltd., 46 East Coast Road, #05-06 Eastgate, Singapore 428766

Tel. (65) 63480378

Fax (65) 63480278

Web Site Address: www.garmin.com or <https://fly.garmin.com/fly-garmin>

This manual reflects the operation of Main System Software versions 2.00, 3.00, 4.00, 5.00, 5.10, 5.30, or later. Some differences in operation may be observed when comparing the information in this manual to earlier or later software versions.

© 2016 Garmin Ltd. or its subsidiaries. All rights reserved. Except as expressly provided herein, no part of this manual may be reproduced, copied, transmitted, disseminated, downloaded or stored in any storage medium, for any purpose without the express written permission of Garmin. Garmin hereby grants permission to download a single copy of this manual and of any revision to this manual onto a hard drive or other electronic storage medium to be viewed for personal use, provided that such electronic or printed copy of this manual or revision must contain the complete text of this copyright notice and provided further that any unauthorized commercial distribution of this manual or any revision hereto is strictly prohibited.

Information in this document is subject to change without notice. Garmin reserves the right to change or improve their products and to make changes in the content of this material without obligation to notify any person or organization of such changes or improvements.

Introduction

Warnings, Cautions, and Notes

WARNING: The altitude calculated by the 400W-series is geometric height above mean sea level and could vary significantly from altitude displayed by pressure altimeters in aircraft.



WARNING: The Jeppesen database incorporated in the 400W-series must be updated regularly in order to ensure that its information is current. Updates are released every 28 days. A database information packet is included in your 400W-series package. Pilots using an out-of-date database do so entirely at their own risk!



WARNING: VNAV is to be used for advisory purposes only. VNAV messages or vertical speed required should not be used to maintain terrain or ATC clearances. Terrain and ATC clearances are the sole responsibility of the pilot.



WARNING: Do not use GPS to navigate to any active waypoint identified as a "NON WGS84 WPT" by a system message. "NON WGS84 WPT" waypoints are derived from an unknown map reference datum that may be incompatible with the map reference datum used by GPS (known as WGS84) and may be positioned in error as displayed.



WARNING: Do not use data link weather information for maneuvering in, near, or around areas of hazardous weather. Information contained within data link weather products may not accurately depict current weather conditions.



WARNING: Do not use the indicated data link weather product age to determine the age of the weather information shown by the data link weather product. Due to time delays inherent in gathering and processing weather data for data link transmission, the weather information shown by the data link weather product may be significantly older than the indicated weather product age.



CAUTION: The Global Positioning System is operated by the United States government, which is solely responsible for its accuracy and maintenance. The system is subject to changes which could affect the accuracy and performance of all GPS equipment. Although the Garmin 400W-series are precision electronic NAVigation AIDs (NAVAID), any NAVAID can be misused or misinterpreted and therefore become unsafe.



CAUTION: Use the 400W-series at your own risk. To reduce the risk of unsafe operation, carefully review and understand all aspects of this Owner's Manual and the Flight Manual Supplement, and thoroughly practice basic operation prior to actual use. When in actual use, carefully compare indications from the 400W-series to all available navigation sources, including the information from other NAVAIDS, visual sightings, charts, etc. For safety, always resolve any discrepancies before continuing navigation.



CAUTION: The electronic chart is an aid to navigation and is designed to facilitate the use of authorized government charts, not replace them. Land and water data is provided only as a general reference to your surroundings. The positional accuracy of the land and water data is not of a precision suitable for use in navigation and it should not be used for navigation. Only official government charts and notices contain all information needed for safe navigation – and, as always, the user is responsible for their prudent use.



CAUTION: The Terrain feature is for supplemental awareness only. The pilot/crew is responsible for all terrain and obstacle avoidance using information not provided by the 400W-series Terrain feature.



CAUTION: The Garmin 400W-series does not contain any user-serviceable parts. Repairs should only be made by an authorized Garmin service center. Unauthorized repairs or modifications could void your warranty and authority to operate this device under FCC Part 15 regulations.



CAUTION: GPS receivers operate by receiving and decoding very low power radio signals broadcast by satellites. It is possible that in some situations other radio equipment or electronic equipment used in close proximity to a GPS receiver may create electromagnetic interference (EMI) which may affect the ability of the GPS receiver to receive and decode the satellite signals. In such event, the interference may be reduced or eliminated by switching off the source of interference or moving the GPS receiver away from it.



NOTE: The GNS 400W-series units use a different database than in the legacy units. The databases are incompatible between units. The GNS 400W-series units must use a WAAS enabled database.

INTRODUCTION

Warnings, Cautions, and Notes



NOTE: This product, its packaging, and its components contain chemicals known to the State of California to cause cancer, birth defects, or reproductive harm. This notice is being provided in accordance with California's Proposition 65. If you have any questions or would like additional information, please refer to our website at www.garmin.com/prop65.



NOTE: It is the pilot's responsibility for initial missed approach guidance in accordance with published procedure. The unit may not provide correct guidance until established on a defined leg.



NOTE: GPS level of service annunciations (LPV, ENR, etc.) are not applicable to the external CDI (or HSI) when VLOC is active.

NOTE: This device complies with Part 15 of the FCC limits for Class B digital devices. This equipment generates, uses, and can radiate radio frequency energy and, if not installed and used in accordance with the instructions, may cause harmful interference to radio communications. Furthermore, there is no guarantee that interference will not occur in a particular installation.

If this equipment does cause harmful interference, the user is encouraged to try to correct the interference by relocating the equipment or connecting the equipment to a different circuit than the affected equipment. Consult an authorized dealer or other qualified avionics technician for additional help if these remedies do not correct the problem.

Operation of this device is subject to the following conditions: (1) This device may not cause harmful interference, and (2) this device must accept any interference received, including interference that may cause undesired operation.

AC 90-100 Statement of Compliance: The Garmin 400W navigational unit meets the performance and functional requirements of AC 90-100A.



NOTE: Do not rely solely upon data link services to provide Temporary Flight Restriction (TFR) information. Always confirm TFR information through official sources such as Flight Service Stations or Air Traffic Control.



NOTE: Canadian installations: In accordance with Canadian Radio Specifications Standard 102 (RSS 102), RF field strength exposure to persons from an antenna connected to this device should be limited to 60V/m for controlled environment and 28 V/m for uncontrolled environment.

To obtain accessories for your 400W-series, please contact your Garmin dealer.

Help us better support you by completing our on-line registration form today! Registration ensures that you will be notified of product updates and new products and provides lost or stolen unit tracking. Please, have the serial number of your unit handy, connect to our web site (www.garmin.com) and look for our Product Registration link on the home page.

The 400W-series display lenses are coated with a special anti-reflective coating which is very sensitive to skin oils, waxes and abrasive cleaners. It is very important to clean the lens using an eyeglass lens cleaner which is specified as safe for anti-reflective coatings and a clean, lint-free cloth.

Garmin is fully committed to your satisfaction as a customer. If you have any questions regarding the 400W-series, please contact our customer service department at:

Garmin International, Inc.
1200 East 151st Street
Olathe, KS 66062-3426 U.S.A.

Phone: (913) 397-8200
Fax: (913) 397-8282

Accessories and Packing List

Congratulations on choosing the world's finest panel-mounted IFR navigation/communication system! The 400W-series represents Garmin's continued commitment to providing you with the most advanced technology available today — in an accurate, easy-to-use design suitable for all of your flying needs.



Unless otherwise specified within this manual, the term "400W-series" applies to the GPS 400W, GNC 420W, GNC 420AW, GNS 430W, and GNS 430AW models. Please note that the difference between these models is indicated in the Specifications section of this manual (see Appendix B).

Before installing and getting started with your new system, please ensure that your package includes the following items. If any parts are missing or are damaged, please contact your Garmin dealer.

Standard Package:

- Garmin 400W-series Unit
- NavData® Card
- Terrain Card
- GPS Antenna
- Installation Rack & Connectors
- Pilot's Guide
- Quick Reference
- 400W/500W Series Display Interfaces Addendum
- 400W/500W Series Garmin Optional Display Interfaces Addendum
- GNS 400W/500W-series Simulator Training CD-ROM
- Database Subscription Packet
- Warranty Registration Card

Upgrade Package:

- Garmin 400W-series Unit
- NavData® Card
- Terrain Card (optional)
- GPS Antenna
- Pilot's Guide & Reference
- Quick Reference
- 400W/500W Series Display Interfaces Addendum
- 400W/500W Series Garmin Optional Display Interfaces Addendum
- GNS 400W/500W-series Simulator Training CD-ROM
- Database Subscription Packet
- Warranty Registration Card

Your Garmin dealer will perform the installation and configuration of your new 400W-series unit. After installation, the NavData® card will already be installed into the correct slot on the front of the unit (see Appendix A). The 400W-series will be secured in the installation rack with the proper wiring connections. Have your dealer answer any questions you may have about the installation — such as location of antennas or any connections to other equipment in the panel.

Limited Warranty

This Garmin product is warranted to be free from defects in materials or workmanship for two years from the date of purchase. Within this period, Garmin will, at its sole option, repair or replace any components that fail in normal use. Such repairs or replacement will be made at no charge to the customer for parts and labor, provided that the customer shall be responsible for any transportation cost. This warranty does not cover failures due to abuse, misuse, accident, or unauthorized alterations or repairs.

THE WARRANTIES AND REMEDIES CONTAINED HEREIN ARE EXCLUSIVE AND IN LIEU OF ALL OTHER WARRANTIES EXPRESS OR IMPLIED OR STATUTORY, INCLUDING ANY LIABILITY ARISING UNDER ANY WARRANTY OF MERCHANTABILITY OR FITNESS FOR A PARTICULAR PURPOSE, STATUTORY OR OTHERWISE. THIS WARRANTY GIVES YOU SPECIFIC LEGAL RIGHTS, WHICH MAY VARY FROM STATE TO STATE.

IN NO EVENT SHALL GARMIN BE LIABLE FOR ANY INCIDENTAL, SPECIAL, INDIRECT OR CONSEQUENTIAL DAMAGES, WHETHER RESULTING FROM THE USE, MISUSE, OR INABILITY TO USE THIS PRODUCT OR FROM DEFECTS IN THE PRODUCT. Some states do not allow the exclusion of incidental or consequential damages, so the above limitations may not apply to you.

Garmin retains the exclusive right to repair or replace the unit or software, or to offer a full refund of the purchase price, at its sole discretion. SUCH REMEDY SHALL BE YOUR SOLE AND EXCLUSIVE REMEDY FOR ANY BREACH OF WARRANTY.

To obtain warranty service, contact your local Garmin Authorized Service Center. For assistance in locating a Service Center near you, visit the Garmin Web site at “<http://www.garmin.com>” or contact Garmin Customer Service at 866-739-5687.

Contents

| | |
|--|-----|
| Introduction | i |
| Warnings, Cautions, and Notes | i |
| Accessories and Packing List | iii |
| Limited Warranty | iv |
| Model Descriptions | 1 |
| GPS 400W..... | 1 |
| GNC 420W/420AW..... | 1 |
| GNS 430W/430AW..... | 1 |
| Takeoff Tour | 1 |
| Key and Knob Functions | 2 |
| Left-hand Keys and Knobs..... | 2 |
| Right-hand Keys and Knobs..... | 3 |
| Bottom Row Keys..... | 4 |
| Power On | 5 |
| Powering up the 400W-Series Unit | 5 |
| Instrument Panel Self-Test | 6 |
| Fuel On Board and Checklists | 7 |
| Acquiring Satellites/Messages | 8 |
| Selecting COM and VLOC Frequencies | 9 |
| Page Groups | 10 |
| Nav Pages | 12 |
| Default Nav Page | 13 |
| Map Page | 14 |
| NavCom Page | 15 |
| Direct-To Navigation | 16 |
| IFR Procedures | 17 |
| Nearest (NRST) Pages | 18 |
| Nearest Airport..... | 19 |
| Nearest Airspace Page | 20 |
| Flight Plans | 21 |
| Section 1 - COM - Communicating Using the GNC 420W/AW and GNS 430W/AW | 23 |
| Volume | 23 |
| Squelch | 23 |
| COM Window and Tuning | 24 |
| Auto-Tuning | 25 |
| Emergency Channel | 27 |
| Stuck Microphone | 27 |
| Remote Frequency Selection Control | 28 |
| Section 2 NAV Pages | 29 |
| Main Page Groups | 29 |
| NAV Page Group | 29 |
| Default NAV Page | 30 |
| Selecting Desired On-Screen Data..... | 31 |
| Restoring Factory Settings..... | 32 |
| Dual Unit Considerations..... | 32 |

| | |
|---|----|
| Map Page | 32 |
| Map Symbols..... | 33 |
| Map Range..... | 33 |
| Map Page Auto Zoom..... | 34 |
| Map Panning..... | 35 |
| Map Direct-To..... | 36 |
| Airspace Information on the Map..... | 36 |
| Map Page Options | 37 |
| Map Setup..... | 37 |
| Data Fields on the Map..... | 40 |
| Selecting Desired On-Screen Data..... | 40 |
| Restoring Factory Settings..... | 41 |
| Terrain Operation | 41 |
| Operating Criteria..... | 41 |
| Terrain Limitations..... | 41 |
| TERRAIN Alerting..... | 42 |
| Baro-Corrected Altitude..... | 42 |
| Terrain Page..... | 42 |
| Inhibit Mode..... | 43 |
| Terrain Symbols..... | 44 |
| General Database Information..... | 45 |
| Database Versions..... | 45 |
| Database Updates..... | 45 |
| Terrain/Obstacle Database Areas of Coverage..... | 46 |
| Navigation Database..... | 46 |
| TERRAIN Alerts | 46 |
| Pop-up Alerts..... | 46 |
| Forward Looking Terrain Avoidance..... | 47 |
| Premature Descent Alerting (PDA)..... | 48 |
| TERRAIN Failure Alert..... | 48 |
| “TERRAIN Not Available” Alert..... | 49 |
| NAVCOM Page | 51 |
| Position Page | 52 |
| Restoring Factory Settings | 54 |
| Satellite Status Page | 55 |
| Vertical Navigation Page | 56 |
| Dead Reckoning | 59 |
| Section 3 Direct-To Navigation | 61 |
| Selecting a Direct-To Waypoint by Facility Name or City | 62 |
| Selecting a Direct-To Waypoint from the Active Flight Plan | 63 |
| Selecting the Nearest Airport as a Direct-To Waypoint | 63 |
| Shortcuts | 64 |
| Cancelling Direct-To Navigation | 65 |
| Specifying a Course to a Waypoint | 65 |
| Selecting Direct-To a Holding Pattern | 66 |
| Section 4 Flight Plans | 67 |
| Flight Plan Catalog | 67 |
| Flight Plan Catalog Editing | 67 |

| | | | |
|--|-----|--|-----|
| Flight Plan Catalog Options | 68 | Section 6 WPT Pages | 117 |
| Activating Flight Plans..... | 68 | WPT Page Group | 117 |
| Inverting Flight Plans | 69 | Duplicate Waypoints | 119 |
| Create a new flight plan..... | 69 | Airport Runway Page | 121 |
| Crossfill | 70 | Airport Frequency Page | 122 |
| Copying Flight Plans | 70 | Airport Approach Page | 124 |
| Deleting Flight Plans | 70 | Airport Arrival Page | 126 |
| Deleting All Flight Plans | 71 | Airport Departure Page | 127 |
| Sort List By Number?/Sort List by Comment? | 71 | Intersection Page | 129 |
| Active Flight Plan Page | 72 | NDB Page | 129 |
| Active Flight Plan Options | 72 | VOR Page | 130 |
| Activate Leg..... | 72 | User Waypoint Page | 131 |
| Crossfill | 73 | Creating User Waypoints | 131 |
| Manual GTN Crossfill | 73 | Creating User Waypoints from the Map Page | 133 |
| Copy Flight Plan..... | 73 | Modifying User Waypoints | 133 |
| Invert Flight Plan..... | 73 | User Waypoint Page Options | 134 |
| Delete Flight Plan..... | 73 | User Waypoint List | 135 |
| Select Approach..... | 74 | Section 7 NRST Pages | 137 |
| Select Arrival..... | 75 | NRST Page Group | 137 |
| Select Departure | 75 | Navigating to a Nearby Waypoint | 139 |
| Remove Approach, Arrival, or Departure | 76 | Nearest Airport Page | 139 |
| Closest Point of FPL | 76 | Nearest Intersection Page | 141 |
| Parallel Track..... | 77 | Nearest NDB Page | 141 |
| Change Fields..... | 78 | Nearest VOR Page | 141 |
| Restore Defaults | 78 | Nearest User Waypoint Page | 142 |
| Shortcuts | 78 | Nearest Center (ARTCC) Page | 142 |
| Flight Plan Transfer Feature (optional with software V 3.20 or later) | 80 | Nearest Flight Service Station (FSS) Page | 143 |
| Section 5 - Procedures - Approaches, Departures, & Arrivals | 83 | Nearest Airspace Page | 144 |
| Basic Approach Operations | 85 | Section 8 VLOC (VOR/Localizer/Glideslope) Receiver Operations | 149 |
| Approaches with Procedure Turns | 86 | Ident Audio and Volume..... | 149 |
| Flying the Procedure Turn | 87 | VLOC Window and Tuning | 149 |
| Flying the Missed Approach | 90 | CDI Key | 152 |
| Flying an Approach with a Hold | 91 | Section 9 AUX Pages | 153 |
| Flying a DME Arc Approach | 94 | AUX Page Group | 153 |
| Vectors to Final | 97 | Flight Planning Page | 154 |
| Flying the Vectors Approach | 98 | Fuel Planning..... | 155 |
| Course From Fix Flight Plan Legs | 100 | Trip Planning..... | 157 |
| ILS Approaches | 104 | Density Alt / TAS / Winds | 158 |
| Selecting an ILS Approach | 105 | Crossfill Operation | 159 |
| Flying the ILS Approach..... | 106 | Scheduler | 161 |
| Selecting an LPV Approach | 109 | Utility Page | 163 |
| Flying the LPV Approach | 110 | Checklists | 165 |
| Flying the LP Approach | 112 | Flight Timers | 166 |
| RNAV Approach Procedures | 113 | Trip Statistics | 167 |
| Points to Remember for All Approaches | 113 | RAIM Prediction..... | 168 |
| Points to Remember for Localizer or VOR-based Approaches | 114 | Sunrise / Sunset | 169 |
| Enabling Autopilot Outputs for the King KAP140/KFC225 | 115 | Software / Database Versions | 169 |

| | |
|--|-----|
| Setup 1 Page | 170 |
| Airspace Alarms..... | 172 |
| CDI Scale / Alarms..... | 173 |
| Units / Mag Var..... | 174 |
| Position Format..... | 175 |
| Map Datum | 175 |
| Date / Time..... | 175 |
| Restoring Factory Settings..... | 176 |
| Setup 2 Page | 176 |
| Display..... | 178 |
| Nearest Airport Criteria..... | 179 |
| SBAS Selection..... | 179 |
| Section 10 Fault Detection & Exclusion | 180 |
| Detection and Exclusion | 180 |
| Section 11 Messages, Abbreviations, and Navigation Terminology | 181 |
| Messages | 181 |
| Turn Advisory and Arrival Annunciations | 188 |
| Flight Plan Transfer Messages | 188 |
| Abbreviations | 189 |
| Navigation Terms | 193 |
| Appendix A NavData Card Use | 195 |
| Appendix B Specifications | 196 |
| Appendix C Troubleshooting Q&A | 197 |
| Index | 203 |

Blank Page

Model Descriptions

This guide covers the operation of the GPS 400W, GNC 420W, GNC 420AW, GNS 430W, GNS 430AW. In general, all models will be referred to as the 400W-series, except where there are physical or operational differences. The 400W-series units are 6.25" wide and 2.66" high. The display is a 240 by 128 pixel color LCD. The units include two removable data cards, one with a Jeppesen database (inserted in the left-most card slot) and the second being a Terrain database (inserted in the right-most card slot).

GPS 400W

The GPS 400W has a WAAS GPS engine and is TSO C146a certified for primary domestic, oceanic, and remote navigation including en route, terminal, and non-precision approaches, and approaches with vertical guidance, such as LPV and LNAV/VNAV. The GPS 400W can simultaneously give aviators vital approach information and weather and traffic data in relation to their position on a color moving map display. Thanks to a high-contrast color display, the information can be easily read from wide viewing angles even in direct sunlight. Its color moving map features a built-in database that shows cities, highways, railroads, rivers, lakes, coastlines, and a complete Jeppesen database. The huge Jeppesen database (that can be updated with a front-loading data card) contains all airports, VORs, NDBs, Intersections, FSS, Approach, DPs/STARs, and SUA information.

Pilots will enjoy the GPS 400W as an MFD, especially when it is coupled with traffic, lightning detection, and weather interfaces like Ryan TCAD, TIS from the Garmin GTX 3xx transponders, or L3 SKYWATCH™, or STORMSCOPE® WX 500. With the PC-based FDE prediction program, the GPS 400W may be used for oceanic or remote operations. For the latest in graphical and textual weather information, the GPS 400W can connect to XM Satellite Radio's XM WX Weather Service via the GDL 69/69A datalink receiver.

GNC 420W/420AW

The GNS 430W/AW includes all of the features of the GPS 400W, and also includes TSO'd airborne VHF communications transceiver. This multipurpose unit is available with either a 10-watt (GNS 420W) or 16-watt 28 V dc (GNS 420AW) COM.

GNS 430W/430AW

The GNS 430W/AW includes all of the features of the GPS 420W/420AW, and also includes TSO'd airborne VOR/Localizer and Glideslope receivers. This multipurpose unit is available with either a 10-watt (GNS 430W) or 16-watt 28 V dc (GNS 430AW) COM.

Takeoff Tour

This Takeoff Tour is intended to provide a brief introduction of the 400W-series major features. The rest of this manual describes these features, and others, in additional detail. Use this guide, as needed, to learn or review the details regarding a particular feature. The Index may be used to quickly locate the information you want. Before flying with your 400W-series unit, take the time to review the information in the manuals and practice with the trainer.

After you're familiar with the basics, some suggested reading within the Reference section includes:

- Flight plan features - Section 4
- Waypoint information pages (database information) - Section 6
- IFR procedures - Section 5
- Unit settings (configuring the unit to your preferences) - Section 9

If you're unable to locate the information you need, we're here to help! Garmin's Customer Service staff is available during normal business hours (U.S. Central time zone) at the phone and fax numbers listed on page ii. You can also reach us by mail (see page ii) or at our web site address: www.garmin.com.

Key and Knob Functions

The 400W-series unit is designed to make operation as simple as possible. The key and knob descriptions on the next three pages provide a general overview of the primary function(s) for each key and knob. This Takeoff Tour section is intended to provide a brief overview of the primary functions of your 400W-series unit. Experiment with the unit and refer to the Reference sections for more information.

Left-hand Keys and Knobs



Left-hand Keys and Knobs

- C
 The **COM power/volume** knob (420W/430W only) controls unit power and communications radio volume. Press momentarily to disable automatic squelch control. In the GPS 400W, this control is used only for power.
- V
 The **VLOC volume** knob (430W only) controls audio volume for the selected VOR/Localizer frequency. Press momentarily to enable/disable the ident tone.
- PUSH C/V
 The **large left** knob (COM/VLOC) (420W/430W only) is used to tune the megahertz (MHz) value (to the left of the decimal point) of the standby frequency for the communications transceiver (COM) or the VLOC receiver, whichever is currently selected by the tuning cursor.



The **small left** knob (COM/VLOC) (420W/430W only) is used to tune the kilohertz (kHz) value (to the right of the decimal point) of the standby frequency for the communications transceiver (COM) or the VLOC receiver, whichever is currently selected by the tuning cursor. Press this knob momentarily to toggle the tuning cursor between the COM and VLOC frequency fields.



The **COM flip-flop** key (420W/430W only) is used to swap the active and standby COM frequencies. Press and hold to select emergency channel (121.500 MHz).





The **VLOC flip-flop** key (430W only) is used to swap the active and standby VLOC frequencies (i.e., make the selected standby frequency active).

Right-hand Keys and Knobs





Right-hand Keys and Knobs

 The **range** key (**RNG**) allows you to select the desired map scale. Use the up arrow side of the key to zoom out to a larger area, or the down arrow side to zoom in to a smaller area.

 The **direct-to** key provides access to the direct-to function, which allows you to enter a destination waypoint and establishes a direct course to the selected destination. See Section 3.

 The **MENU** key displays a context-sensitive list of options. This options list allows you to access additional features or make settings changes which relate to the currently displayed page.

 The **clear** key (**CLR**) is used to erase information or cancel an entry. Press and hold this key to immediately display the Default Navigation Page, regardless of which page is currently displayed.

 The **enter** key (**ENT**) is used to approve an operation or complete data entry. It is also used to confirm information, such as during power on.

 The **large right** knob is used to select between the various page groups: NAV, WPT, AUX or NRST. With the on-screen cursor enabled, the large right knob allows you to move the cursor about the page.

 The **small right** knob (**CRSR**) is used to select between the various pages within one of the groups listed above. Press this knob momentarily to display the on-screen cursor. The cursor allows you to enter data and/or make a selection from a list of options.

Bottom Row Keys

- NRST** The **nearest (NRST)** key (400W/420W only) displays the nearest airports page. Then, turning the **small right** knob steps through the NRST pages.
- CDI** The **CDI** key (430W only) is used to toggle which navigation source (GPS or VLOC) provides output to an external HSI or CDI.
- OBS** The **OBS** key is used to select manual or automatic sequencing of waypoints. Pressing the **OBS** key selects OBS mode, which will retain the current “active to” waypoint as your navigation reference even after passing the waypoint (i.e., prevents sequencing to the next waypoint). Pressing the **OBS** key again will return to normal operation, with automatic sequencing of waypoints. Whenever OBS mode is selected, you may set the desired course to/from a waypoint using the OBS Page, or an external OBS selector on your HSI or CDI.
- MSG** The **message** key (**MSG**) is used to view system messages and important warnings and requirements. See Sections 11 and 9 for more information on messages and unit settings.
- The **flight plan** key (**FPL**) allows you to create, edit, activate and invert flight plans, as well as access approaches, departures and arrivals. A closest point to flight plan feature is also available from the flight plan key. See Section 4 for more information on flight plans.



GPS 400W / GNC 420W



GNS 430W



Whenever the 400W-series unit is displaying a list of information that is too long for the display screen, a scroll bar will appear along the right-hand side of the display. The scroll bar graphically indicates the number of additional items available within the selected category.

Simply press the small right knob to activate the cursor and turn the large right knob to scroll through the list.

- PROC** The **procedures** key (**PROC**) allows you to select and remove approaches, departures and arrivals from your flight plan. When using a flight plan, available procedures for your departure and/or arrival airport are offered automatically. Otherwise, you may select the desired airport, then the desired procedure.

Power On

The Garmin 400W-series provides you accurate navigational data and some models also have communication capability, along with non-precision and precision approach certification in the IFR environment. The Takeoff Tour is designed to familiarize you with the operation of the 400W-series — including powering up the unit, changing frequencies, entering data, performing a simple direct-to, selecting IFR procedures and provides a limited introduction to using flight plans. In addition, this section briefly covers the default navigation, map and frequency pages available as part of the NAV page group. These pages will be used for most of your in-flight navigation.

The Takeoff Tour assumes that the unit and antennas have been properly installed and you have not changed any of the 400W-series unit default settings. If you have changed any of the factory default settings (position format, units of measure, selectable fields, etc.), the pictures shown here may not exactly match what you see on your 400W-series unit. Prior to using your unit for the first time, we recommend that you taxi to a location that is well away from buildings and other aircraft so the unit can collect satellite data without interruption.

Powering up the 400W-Series Unit

The 420W and 430W power and COM volume are controlled using the **power/volume** knob at the top left corner of the unit. The 400W **power** knob is located at the top left corner of the unit. Turning it clockwise will turn unit power on and increase the COM radio volume. After turning the unit on, a *Welcome page* will be displayed while the unit performs a self test, followed by the database confirmation pages which show the current database information on the NavData card (with the valid operating dates, cycle number and database type indicated). The database is updated every 28 days, and must be current for approved instrument approach operations. Information on database subscriptions is available inside your 400W-series package.

To acknowledge the database information, press ENT.



Power-up Sequence

TAKEOFF TOUR

Instrument Panel Self-Test

Check CDI/HSI, RMI and other instruments to verify these indications

Fuel Figures: May be entered manually if no sensor present

Select to Set Fuel Level to Full Capacity

Should match current OBS course selection

Select to display Checklists Page

| INSTRUMENT PANEL SELF-TEST | | | | | |
|----------------------------|------------------|------------------|-------|----------------|-----|
| LCDI | Half Left | CAP | 120? | | |
| LFLG | Out of View | FOB | 110? | | |
| VCDI | Half Up | FF | 14.0? | | |
| VFLG | Out of View | | | | |
| TO/FRM | RHI | OBS | | Set Full Fuel? | |
| To | 135° | 350 _M | | Go To Chklist? | OK? |
| ANNUN | DTK | | | | |
| On | 150 _M | | | | |

Instrument Panel Self-Test

Once the database has been acknowledged, the instrument panel self-test page will appear. To ensure that your 400W-series unit and any connected instruments are working properly, check for the following indications on your CDI/HSI, RMI, external annunciators and other connected instruments:

- Course deviation
- Glideslope
- TO/FROM flag
- Time to destination
- Bearing to destination
- Desired track
- Distance to dest.
- Ground speed
- All external annunciators (if installed)

The *instrument panel self-test page* indicates the currently selected OBS course, fuel capacity (CAP), fuel on board (FOB) and fuel flow (FF). The fuel capacity, fuel on board and fuel flow may be manually entered if your installation does not include connection to sensors which automatically provide these figures.

To enter fuel capacity, fuel on board or fuel flow figures (if not provided by sensors):

1. Turn the **large right** knob to select the "CAP", "FOB" or "FF" field.
2. Turn the **small and large right** knobs to enter the desired figure, then press **ENT**.

| INSTRUMENT PANEL SELF-TEST | | | | | |
|----------------------------|------------------|------------------|--------|----------------|-----|
| LCDI | Half Left | CAP | 00120? | | |
| LFLG | Out of View | FOB | 110? | | |
| VCDI | Half Up | FF | 14.0? | | |
| VFLG | Out of View | | | | |
| TO/FRM | RHI | OBS | | Set Full Fuel? | |
| To | 135° | 350 _M | | Go To Chklist? | OK? |
| ANNUN | DTK | | | | |
| On | 150 _M | | | | |

| INSTRUMENT PANEL SELF-TEST | | | | | |
|----------------------------|------------------|------------------|--------|----------------|-----|
| LCDI | Half Left | CAP | 120? | | |
| LFLG | Out of View | FOB | 110? | | |
| VCDI | Half Up | FF | 012.0? | | |
| VFLG | Out of View | | | | |
| TO/FRM | RHI | OBS | | Set Full Fuel? | |
| To | 135° | 350 _M | | Go To Chklist? | OK? |
| ANNUN | DTK | | | | |
| On | 150 _M | | | | |

Enter the fuel capacity, fuel on board or fuel flow figures directly onto the appropriate field of the instrument panel self-test page. These figures will automatically be provided if your installation includes connection to external sensors.

Fuel On Board and Checklists

The *instrument panel self-test page* includes selections to set fuel on board (FOB) to full capacity and access the *checklists page*. This allows you to quickly set fuel to full limits and display any checklists you've entered, such as start up or takeoff checklists.

To set fuel on board to full (if not provided by sensor):

1. Turn the **large right** knob to highlight "Set Full Fuel?".



Select "Set Full Fuel?" to set fuel on board (FOB) to full capacity.

2. Press **ENT** and verify that fuel on board ("FOB") now matches the fuel capacity (CAP) figure. Fuel on board will now be reduced, over time, based on the fuel flow (FF) figure.

To view the checklists page:

1. Turn the **large right** knob to highlight "Go To Chklist?" and press **ENT**.

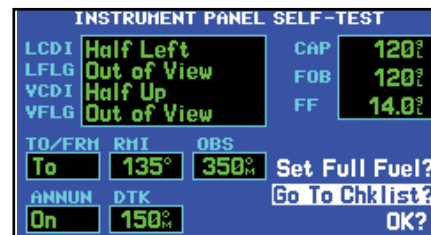

Select "Go To Chklist?" to display the checklist page and any available checklists. The 400W-series unit can hold up to nine checklists with up to 30 entries in each checklist.

2. Turn the **large right** knob to select the desired checklist, then follow the steps in *Section 9 - Aux Pages - Utility Page* to execute each step in the selected checklist.
3. Once you complete the desired checklist(s), press the **small right** knob to return to the checklists page. Press the **small right** knob again to return to normal operation on the satellite status or map pages.

Once you've verified instrument operation with the instrument panel self-test page displayed, press the ENT key.

The *satellite status page* will appear as the 400W-series unit begins to collect satellite information. An "Acquiring" status will be displayed on the *satellite status page*, and the signal strength of any satellites received will appear as "bar graph" readings. This is a good indication that you are receiving signals and a position fix will be determined. Following the first-time use of your 400W-series unit, the time required for a position fix will vary—within two minutes.

Acquiring Satellites/Messages

If the 400W-series unit has not been operated for a period of six months or more, it may have to “Search the Sky” to collect new data. This means the unit is acquiring satellite data to establish almanac and satellite orbit information, which can take 5 to 10 minutes. The Satellite Status Page displays a “Searching Sky” status, and the message annunciator (MSG) above the **MSG** key also flashes to alert you of a system message, “Searching the Sky”.

The Time and other data may not be displayed until the unit has acquired enough satellites for a fix.

To view a system message, press the MSG key.



Message Page

The *message page* will appear and display the status or warning information applicable to the receiver’s current operating condition.

To return to the previous page after viewing a message, press the MSG key again.

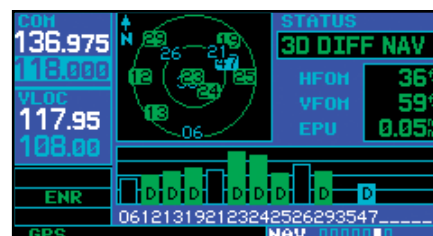

The satellite status page shows the ID numbers for the satellites and the relative signal strength of each satellite received (as a “bar graph” reading).

“Searching Sky” indicates that satellite almanac data is not available. The data is recollected from the first available satellite.

“Acquiring” indicates that satellites have been located and information is being acquired, but the receiver does not have enough satellites for a 3-dimensional position.

“3D NAV” indicates that a 3-dimensional position is available.

“3D DIFF NAV” indicates when a 3-dimensional position is available and differential corrections are being used.

The “INTEG” annunciator (bottom left corner of the screen) indicates that satellite coverage is insufficient to pass built-in integrity monitoring tests.

Selecting COM and VLOC Frequencies

While the 400W-series unit is acquiring a position, let's take a minute to dial in the active and standby frequencies you'll be using for the first phase of your flight. The 400W-series display is divided into separate "windows" (or screen areas), including a COM window, VLOC window, and the GPS window.

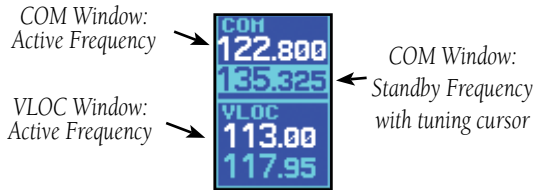

Pushing the **small left** knob activates the tuning cursor in the desired frequency window. To select the active frequency, you must first enter the frequency in the standby field, and use the **COM flip-flop** (or **VLOC flip-flop**) key to move it to the active field.

To change the standby communication (COM) or VLOC frequency:

1. If the tuning cursor is not currently in the desired window (COM or VLOC), press the **small left** knob momentarily to switch the highlight between the COM and VLOC windows. Adjusting the frequencies with the **large** and **small left** knobs will affect the standby frequency.
2. Turn the **large left** knob to select the desired megahertz (MHz) value. For example, the "135" portion of the frequency "135.325".
3. Turn the **small left** knob to select the desired kilohertz (kHz) value. For example, the ".325" portion of the frequency "135.325".
4. To activate the selected frequency, press the appropriate **flip-flop** key—COM for communication frequencies or VLOC for VOR/Localizer frequencies.

Once you've entered the active frequency, simply repeat steps 1 through 3, above, to enter the standby frequency. After both communication frequencies have been entered, you may elect to keep the COM window 'hot' by leaving the cursor on the standby frequency, or move the cursor to the VLOC window by pressing the **small left** knob.

Once you've entered the active frequency, simply repeat steps 1 to 3, above, to enter the standby frequency. After both communication frequencies have been entered, you may elect to keep the COM window "hot" by leaving the cursor on the standby frequency, or move the cursor to the VLOC window by pressing the **small left** knob.



NOTE: When selecting VLOC frequencies, the tuning cursor automatically returns to the COM window after 30 seconds of inactivity.



NOTE: GPS level of service annunciations (LPV, ENR, etc. as shown on page 83) are not applicable to the external CDI (or HSI) when VLOC is active.

These features are only available in the 420W/430W units.

Page Groups



(Large right knob to change page groups)

NAV Group

(Small right knob to select pages within the group)



Default NAV

(Small right knob to select pages within the group)



Map

(Small right knob to select pages within the group)



Terrain

(Small right knob to select pages within the group)

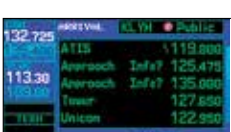

NAVCOM

(Small right knob to select pages within the group)

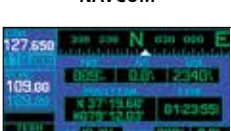

Position

(Small right knob to select pages within the group)



Satellite Status

(Small right knob to select pages within the group)



VNAV

WPT Group

(Small right knob to select pages within the group)



Arpt Location

(Small right knob to select pages within the group)



Arpt Departure

(Small right knob to select pages within the group)



Arpt Runway

(Small right knob to select pages within the group)



Intersection

(Small right knob to select pages within the group)

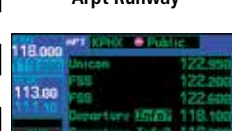

Arpt Frequency

(Small right knob to select pages within the group)



NDB

(Small right knob to select pages within the group)



Arpt Approach

(Small right knob to select pages within the group)



VOR

(Small right knob to select pages within the group)

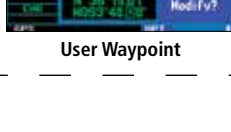

Arpt Arrival

(Small right knob to select pages within the group)



User Waypoint

Selection of any main page is performed using the **large** and **small right** knobs. The **large right** knob selects the page group: NAV, WPT, AUX or NRST. The **small right** knob selects the desired page within a group. To quickly select the default NAV page, press and hold the **CLR** key.



(Large right knob to change page groups)

PUSH CRSR

(Large right knob to select pages with the group)

| AUX Group | NRST Group | |
|--|--|--|
|  <p>Flight Planning</p> |  <p>Nrst Airport</p> |  <p>Nrst User Waypt</p> |
|  <p>Utility</p> |  <p>Nrst Intersection</p> |  <p>Nrst Center</p> |
|  <p>Setup 1</p> |  <p>Nrst NDB</p> |  <p>Nrst Flight Service</p> |
|  <p>Setup 2</p> |  <p>Nearest VOR</p> |  <p>Nrst Airspace</p> |

FPL Group

Flight plan pages are selected by pressing the **FPL** key and using the **small right** knob to select the desired page.



Active Flight Plan



Flight Plan Catalog

PROC Group

The Procedures pages are selected by pressing the **PROC** key and using the **small or large right** knobs to select a procedure.

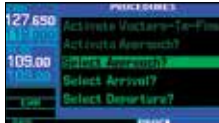

Procedure

Nav Pages

The map page is one of seven, or more, pages available under the NAV group*:

- Default NAV page
- Terrain page
- Position page
- Vertical navigation page
- Map page
- NAVCOM page
- Satellite status page

To select the desired NAV page, turn the small right knob until the desired page is displayed.

If you are currently viewing a page that is not part of the NAV group, you can quickly return to the NAV group using the **CLR** key.

To select the NAV group and display the default NAV page, press and hold CLR.

| NAV |
|---|
| 7+ available pages* (see list above) |

| WPT |
|---------------------------------------|
| 10 available pages (see Section 6) |

| AUX |
|--------------------------------------|
| 4 available pages (see Section 9) |

| NRST |
|--------------------------------------|
| 8 available pages (see Section 7) |

MAIN PAGE GROUPS

In addition to the NAV group of pages, additional groups of pages are available for waypoint information (WPT), auxiliary (AUX) functions such as flight planning or unit settings, and listings for nearest (NRST) airports or other facilities.

To select the desired page group, turn the large right knob until a page from the desired group is displayed.

To select the desired page within the group, turn the small right knob until the desired page is displayed.



The bottom right corner of the screen indicates the page group currently being displayed (e.g., NAV or NRST), the number of screens available within that group (indicated by square icons) and the placement of the current screen within that group (indicated by a highlighted square icon). To select a different page within the group, turn the small right knob.

* Seven, or more, NAV Pages are available when the 400W-series installation includes connection to traffic, XM radio, and/or weather information sources. See the 400W/500W Series Display Interfaces Pilot's Guide Addendum, part number 190-00356-31 and the 400W/500W Series Garmin Optional Displays Pilot's Guide Addendum, part number 190-00356-30.

Default Nav Page

During most flights, the *default NAV*, *map* and *NAVCOM* pages will be the primary pages used for navigation. The *default NAV page* displays a graphic course deviation indicator (CDI), the active leg of your flight plan (as defined by the current “from” and “to” waypoints), and six user-selectable data fields. The default settings for these fields are distance to waypoint (DIS), desired track (DTK), bearing to waypoint (BRG), ground speed (GS), ground track (TRK) and estimated time en route (ETE). See Section 11 for definitions of these navigation terms. The *default NAV page* is selected by pressing and holding the **CLR** key or turning the **small right** knob.

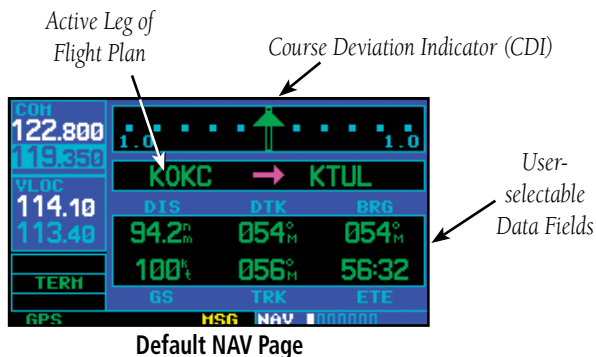

To change the data fields in the corners of the Default NAV Page:

1. Press **MENU** (with the Map Page displayed).
2. Turn the **large right** knob to highlight “Change Fields?” and press **ENT**.
3. Turn the **large right** knob to highlight the data field you wish to change.

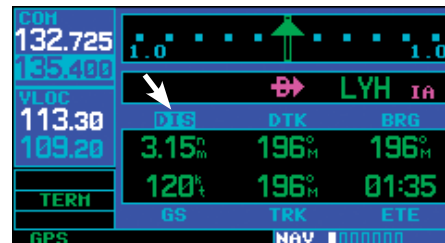

4. Turn the **small right** knob to select the type of data you want to appear on this field and press **ENT**.



5. Press the **small right** knob to remove the cursor.

Map Page

The *map page* displays your present position (using an airplane symbol) relative to nearby airports, VORs, NDBs, intersections, user waypoints and airspace boundaries—and your route displayed as a solid line. Data fields for destination waypoint (WPT), distance to waypoint (DIS), desired track (DTK) and ground speed (GS) appear on the right hand side of the display. These fields are user-selectable to allow you to configure the unit to your own preferences. Available settings include: altitude, bearing, en route safe altitude, estimated time of arrival, minimum safe altitude, and ground track. See Section 11 for definitions of these navigation terms.

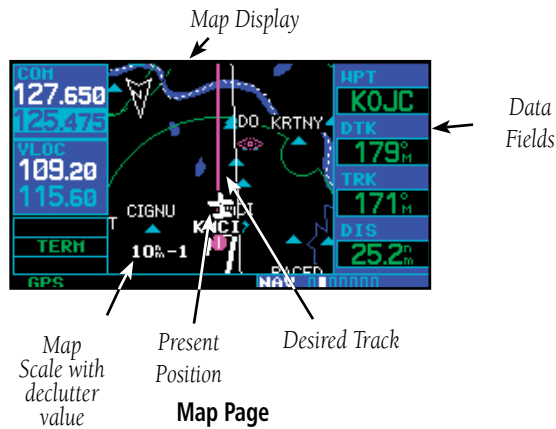

The map page combines a moving map display and navigation data for complete situational awareness. Map setup pages are provided to designate the maximum scale at which each map feature will appear. These settings provide an automatic decluttering of the map (based upon your preferences) as you adjust the scale.

While viewing the map page, you can quickly declutter and remove many of the background map details by pressing the CLR key (repeatedly) until the desired detail is depicted.

To change the map scale, press the ▼ or ▲ sides of the RNG key.

NavCom Page

From the *default NAV page*, simply turn the **small right** knob to display the *map page* and again to display the *NAVCOM page*. The *NAVCOM page* displays the available frequencies (communications and navigation) for the departure airport, any en route airports that are included in your flight plan, and the final destination airport. When using the direct-to function, frequencies will be listed for the airport nearest to your starting position and the destination airport.

A frequency listed on the *NAVCOM page* can be quickly transferred to the standby field of the COM or VLOC windows. This time-saving process prevents having to “re-key” a frequency already displayed elsewhere on the screen.

To display the frequency list for the active flight plan or direct-to airport:

1. In the Nav function, turn the **small right** knob to reach the NAVCOM page.
2. Push the **small right** knob to activate the cursor on the airport identifier field (in the GPS window). Turn the **small right** knob to display the list of airports (departure, arrival and en route) for your flight plan or direct-to. Continue to turn the **small right** knob until the desired airport is selected.
3. Press **ENT** to display the frequency list for the selected airport.



Press ENT to show the frequencies for the selected airport.

To select a communication or navigation frequency:

1. On the NAVCOM page, push the **small right** knob to activate the cursor in the GPS window.
2. Turn the **large right** knob to select the desired frequency from the list.



Selecting a frequency on the NAVCOM page.

3. Press **ENT** to transfer the selected frequency to the standby field in the COM or VLOC window. COM frequencies will automatically go to the standby field of the COM window and navigation frequencies will automatically go to the standby field of the VLOC window, regardless of which window is currently highlighted by the cursor.
4. To activate the selected frequency, press the **COM flip-flop** (or **VLOC flip-flop**) key.



Swap the standby COM frequency into the active Com frequency location.

Direct-To Navigation

The 400W-series unit can use direct point-to-point navigation to guide you from takeoff to touchdown, even in the IFR environment. Once a destination is selected, the unit will provide speed, course and distance data based upon a direct course from your present position to your destination. A destination can be selected from any page with the **direct-to** key.

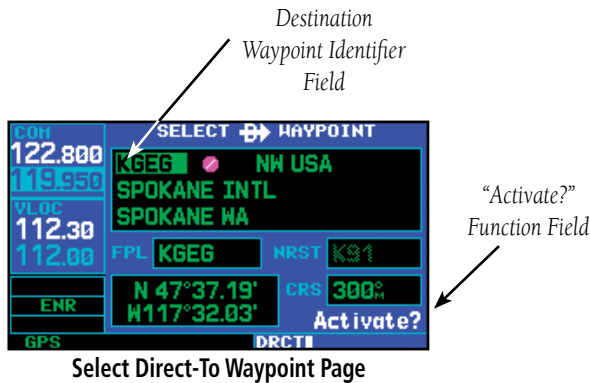

To select a direct-to destination:

1. Press the **direct-to** key. The Select Direct-To Waypoint page will appear with the destination field highlighted. The direct-to waypoint may also be selected by facility or city name. See Section 3 for more information.
2. Turn the **small right** knob to enter the first letter of the destination waypoint identifier. The destination waypoint may be an airport, VOR, NDB, intersection or user waypoint, as long as it is in the database or stored in memory as a user waypoint.
3. Turn the **large right** knob to the right to move the cursor to the next character position.
4. Repeat steps 2 and 3 to spell out the rest of the waypoint identifier.

5. Press **ENT** to confirm the identifier. The "Activate?" function field will be highlighted.



Confirm the selected direct-to destination by highlighting "Activate?" and pressing ENT.

6. Press **ENT** to activate a direct-to course to the selected destination.



Once a direct-to destination is selected, press and hold **CLR** to display the default NAV page.

You can then press and hold the **CLR** key to return to the default NAV page, as desired.

IFR Procedures

Once the direct-to or flight plan is confirmed, the whole range of instrument procedures is available to you. Departures (SIDs), arrivals (STARs), non-precision and precision approaches are stored within the NavData card and available using the **PROC** (procedures) key.

To display the procedures page, press PROC.

The steps required to select and activate an approach, departure or arrival are identical. In this introductory section, we'll show examples of the steps required to select an approach, but keep in mind the same process also applies to departures and arrivals.

To select an approach, departure, or arrival:

1. Turn the **small right** knob to select the desired option ("Select Approach?", "Select Arrival?" or "Select Departure?") from the procedures page.

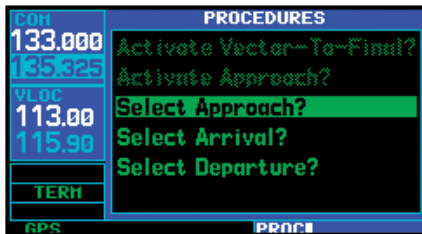

Press the PROC key to display the procedures page. Turn the large right knob to select the desired option.

2. Press **ENT** to display a list of available procedures for the arrival (when using approaches or STARs) or departure (when using SIDs) airport.
3. Turn the **small right** knob to select the desired procedure and press **ENT**.

4. For approaches, a window appears to select the desired initial approach fix (IAF) or provide a "vectors" option to select just the final course segment of the approach. Turn the **small right** knob to select the desired option and press **ENT**. Vectors guidance is relative to the final inbound course. A line is drawn beyond the final approach fix, allowing you to intercept the final course segment beyond its normal limits.

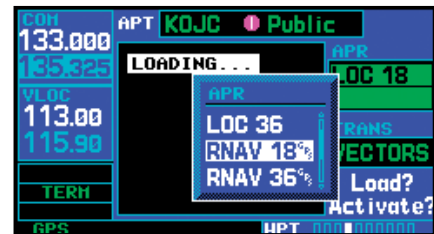

A window will appear to select the desired procedure. Use the large right knob to make your selection.

5. For departures and arrivals, a window appears to select the desired transition. Turn the **small right** knob to select the desired option and press **ENT**.
6. With "Load?" highlighted, press **ENT** to add the procedure to the flight plan or direct-to.

In your flight plan or direct-to, the departure or arrival airport is replaced with the sequence of waypoints contained within the selected procedure.

Nearest (NRST) Pages

The NRST main page groups provides listings for nearest airports or other facilities. The NRST group provides detailed information on the 25 nearest airports, VORs, NDBs, intersections and user-created waypoints within 200 NM of your current position. In addition, pages are also provided to display the five nearest center (ARTCC/FIR) and Flight Service Station (FSS) points of communication, plus alert you to any special-use or controlled airspace you may be in or near.

The *nearest airport page* is one of eight pages available under the NRST group:

- Nearest airport page
- Nearest intersection page
- Nearest NDB page
- Nearest VOR page
- Nearest user waypoints page
- Nearest ARTCC page
- Nearest FSS page
- Nearest airspace page

To display the NRST pages:

1. If necessary, press the **small right** knob to remove the cursor from the page.
2. Turn the **large right** knob to select the NRST page group, as indicated by "NRST" appearing in the lower right corner of the screen.

| CON | APT | BRG | DIS | APR |
|---------|------|---------|-------|--------|
| 133.000 | KMKC | 100% | 6.2m | ILS |
| 115.900 | twr | 133.300 | rwyt | 7001% |
| 113.00 | KMCI | 359% | 9.0m | ILS |
| 115.90 | twr | 128.200 | rwyt | 10801% |
| | 51K | 208% | 15.0m | VFR |
| | uni | 122.700 | rwyt | 2440% |

GPS NRST

To display a list of nearby airports, turn the **large right** knob to select the NRST page group and (if needed) the **small right** knob to select the nearest airport page.

3. Press and then turn the **large right** knob to select the desired NRST page.

| CON | APT | BRG | DIS | APR |
|---------|------|---------|-------|-------|
| 133.000 | 51K | 233% | 8.9m | VFR |
| 115.900 | uni | 122.700 | rwyt | 2440% |
| 113.00 | KMCI | 359% | 9.0m | ILS |
| 115.90 | twr | 133.300 | rwyt | 7001% |
| | KOJC | 179% | 10.0m | LOC |
| | twr | 126.000 | rwyt | 4098% |

GPS NRST

To scroll through the list, press the **small right** knob, then turn the **large right** knob.

Nearest Airport

You may examine both the communication frequencies and runway information directly from the nearest airport page. As discussed earlier for the NAVCOM page, you may also place any displayed frequency into the standby COM or VLOC field by highlighting the frequency with the cursor and pressing **ENT**.

To view additional information for a nearby airport from the Nearest Airport page:

1. Press the **small right** knob to activate the cursor.
2. Turn the **large right** knob to select the desired airport from the list.
3. Press **ENT** to display waypoint (WPT) information pages for the selected airport.



Additional information for a nearby airport is available by highlighting an identifier on the list and pressing ENT.

4. To display runway and frequency information, press the **small right** knob to remove the cursor and turn the **small right** knob to display the desired information page.

The *nearest airport page* may be used in conjunction with the **direct-to** key to quickly set a course to a nearby facility in an in-flight emergency. Selecting a nearby airport as a direct-to destination will override your flight plan or cancel a previously selected direct-to destination. You'll still have the option of returning to your flight plan by cancelling the direct-to.

To select a nearby airport as a direct-to destination:

From the nearest airport page...

1. Press the **small right** knob to activate the cursor.
2. Turn the **large right** knob to select the desired airport from the list.
3. Press **direct-to**, **ENT**, and **ENT** (again) to navigate to the nearby airport.



To select a nearby airport as a new destination, highlight its identifier, press **direct-to**, **ENT**, and **ENT** (again).

From an airport information page...

1. Press **direct-to**, **ENT**, and **ENT** (again) to navigate to the nearby airport.

Nearest Airspace Page

The last page in the NRST group, the *nearest airspace page*, provides information for up to nine controlled or special-use airspaces near or in your flight path. Airspace information appears on this page based upon the same criteria used for airspace alert messages. Nearby airspace information and airspace alert messages are provided according to the following conditions:

- If your projected course will take you inside an airspace within the next ten minutes, the message “Airspace ahead -- less than 10 minutes” will appear.
- If you are within two nautical miles of an airspace and your current course will take you inside, the message “Airspace near and ahead” will appear.
- If you are within two nautical miles of an airspace and your current course will not take you inside, the message “Near airspace less than 2NM” will appear.
- If you have entered an airspace, the message “Inside Airspace” will appear.

By default, airspace alert messages are turned off. When turned on, the message (MSG) annunciator located directly above the **MSG** key will flash to alert you to the airspace message. (See *Section 9 Aux Pages - Setup 1* for information on enabling airspace alert messages.)

To view an airspace alert message:

1. Press the **MSG** key. The message page appears with the alert message.



When an airspace alert occurs, the message (MSG) annunciator will flash. Press MSG to view the alert message.

2. Press **MSG** again to return to the previous display.

To view nearest airspace information:

1. Turn the **large right** knob to reach the NRST function.

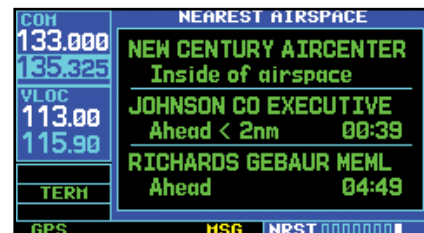

To view additional information about the airspace, select the nearest airspace page. Detailed information is available by highlighting the airspace name and pressing ENT.

2. Turn the **small right** knob to reach the Nearest Airspace page.

Note that the airspace alerts are based upon three-dimensional data (latitude, longitude and altitude) to avoid nuisance alerts. The alert boundaries for controlled airspace are also sectorized to provide complete information on any nearby airspace. Additional information about a nearby airspace—such as controlling agency, frequency and floor/ceiling limits—is available

from the *nearest airspace page*.

Flight Plans

The 400W-series lets you create up to 20 flight plans, with up to 100 waypoints in each flight plan. Flight plans are created, edited and activated using the **FPL** key. The FPL page group includes two pages: the *active flight plan page* and the *flight plan catalog*. The *active flight plan page* provides information and editing features for the flight plan currently in use (referred to as “flight plan 00”). The *flight plan catalog* serves as the main page for creating new flight plans, as well as editing or activating previously created flight plans.



Active flight plan page with flight plan currently in use.

Since using flight plans is arguably one of the more complex features of the 400W-series, we'll only discuss it briefly here — focusing on creating a new flight plan and activating it to use for navigation. Additional information about flight plans can be found in *Section 4 Flight Plans*.

To create a new flight plan:

1. Press the **FPL** key and turn the **small right** knob to select the flight plan catalog.
2. Press the **MENU** key to display the flight plan catalog options.
3. Turn the **large right** knob to select “Create New Flight Plan?” and press **ENT**.



To create a new flight plan, select “Create New Flight Plan?” from the flight plan catalog options.

4. The cursor will appear on the first waypoint identifier field (located directly below “WAYPOINT”). Use the **large** and **small right** knobs to enter the identifier of the first waypoint in the flight plan. (The **small** knob is used to select the desired letter or number and the **large knob** is used to move to the next character space.)



Enter the identifier for each airport and/or navaid into the flight plan in the same sequence you wish to fly.

5. Press **ENT** once the identifier has been selected. The cursor will move to the next blank waypoint

identifier field.

- Repeat steps 4 and 5, above, until all waypoints for the flight plan have been entered. Once the flight plan is created, it may be activated from an options window. Activating the flight plan will place a copy into “flight plan 00” (the original flight plan still resides in the flight plan catalog). It replaces any flight plan which currently exists in “flight plan 00.”

To activate the new flight plan:

- On the Flight Plan Catalog page, press the **small right** knob to activate the cursor. Rotate the **large right** knob to highlight the desired flight plan.
- Press the **MENU** key to display the flight plan catalog options.
- Turn the **small right** knob to select “Activate Flight Plan?” and press **ENT**.



Select “Activate Flight Plan?” from the page menu to begin using the new flight plan.

420W / 430W Only

Section 1 - COM - Communicating Using the GNC 420W/AW and GNS 430W/AW

Some models of the 400W-series feature a digitally-tuned VHF COM radio that provides a seamless transition from communication to navigation. The GNC 420W and GNS 430W's COM radio operates in the aviation voice band, from 118.000 to 136.975 MHz, in 25 kHz steps (default). For European operations, a COM radio configuration of 8.33 kHz steps is provided (Section 9 - Aux - Setup 2). The GNC 420AW and GNS 430AW use a 16-watt transmitter, instead of the standard 10-watt transmitter.



"TX" appears at the upper right corner of the screen while transmitting.

Volume

COM radio volume is adjusted using the **COM power/volume** knob. Turn the **COM power/volume** knob clockwise to increase volume, or counterclockwise to decrease volume.

Squelch

The COM radio features an automatic squelch to reject many localized noise sources. You may override the squelch function by pressing the **COM power/volume** knob. This facilitates listening to a distant station or setting the desired volume level.



Press the **COM power/volume** knob momentarily to override the automatic squelch. Note the "RX" receive indication when receiving a station.

To override the automatic squelch, press the **COM power/volume** knob momentarily. Press the **COM power/volume** knob again to return to automatic squelch operation.

COM Window and Tuning

Communication frequencies are selected with the tuning cursor in the *standby* COM frequency field, and using the **small** and **large left** knobs to dial in the desired frequency. The standby frequency always appears below the *active* frequency. The active frequency is the frequency currently in use for transmit and receive operations.



Tuning cursor in the COM window. Use the small and large left knobs to dial in the desired standby frequency.

A frequency may also be quickly selected from the database by simply highlighting the desired frequency on any of the main pages and pressing the **ENT** key. This process is referred to as *auto-tuning*. Once a frequency is selected in the standby field, it may be transferred to the active frequency by pressing the **COM flip-flop** key.

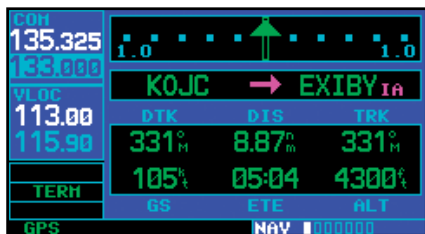

Once the standby frequency is selected, use the **COM flip-flop** key to make the frequency active for transmit and receive operations.

While receiving a station, an “RX” indication appears in the upper right corner of the COM window — to the immediate right of “COM”. A “TX” indication appears at this location while you are transmitting.



NOTE: The tuning cursor will normally appear in the COM window, unless placed in the VLOC window by pressing the **small left knob**. When the tuning cursor is in the VLOC window, it will automatically return to the COM window after 30 seconds of inactivity. This does not apply to the GNS 420W.

The active frequency in either window cannot be accessed directly—only the standby frequency will be highlighted by the tuning cursor.

To select a COM frequency:

1. If the tuning cursor is not currently in the COM window, press the **small left** knob momentarily.
2. Turn the **large left** knob to select the desired megahertz (MHz) value. For example, the “118” portion of the frequency “118.300”.
3. Turn the **small left** knob to select the desired kilohertz (kHz) value. For example, the “.300” portion of the frequency “118.300”.

To make the standby frequency the active frequency, press the COM flip-flop key.

The tuning cursor will remain in the *COM window*. The GNS 430W/AW unit has a built-in VOR/Localizer/ Glideslope capability. If you wish to select a VOR/ localizer/ILS frequency, press the **small left** knob momentarily to place the cursor in the *VLOC window*. Additional instructions for VOR/localizer/ILS operations are available in Sections 5 and 8.



Cursor in VLOC window allows for VOR and ILS operations. See Section 8.

Auto-Tuning

The 400W-series auto-tune feature allows you to quickly select any database frequency in the GPS window as your standby frequency. Any COM frequency displayed in the GPS window can be transferred to the standby COM frequency field, with a minimum of keystrokes required. The following are some examples of selecting COM frequencies from some of the main GPS pages.

To select a COM frequency for a nearby airport:

1. Select the nearest airport page from the NRST page group. Press and hold the **CLR** key, then turn the **large right** knob until the nearest pages appears. Finally, if necessary, turn the **small right** knob to display the nearest airport page.
2. Press the **small right** knob momentarily to place the cursor on the airport identifier field of the first airport in the list. Turn the **large right** knob to highlight the desired airport frequency.

3. Press **ENT** to place the frequency in the standby field of the COM window.



Nearest airport page with the Tower frequency (TWR) for the closest airport highlighted.

4. Press the **Com flip/flop** key to swap the standby and active frequencies.



From the nearest airport page, select the desired airport to show a more detailed listing of frequencies for that airport.

5. Before leaving the frequency page, use the **large right** knob to highlight "Done?" and press **ENT**. "Done?" always needs to be acknowledged before leaving a page group.

To select a COM frequency for a nearby flight service station (FSS) or center (ARTCC):

1. Select the nearest center or flight service page from the NRST page group. Turn the **large right** knob until the NRST pages appear. Then, if necessary, turn the **small right** knob to display the desired NRST page.



Use the nearest ARTCC page to quickly retrieve the frequency(s) for the nearest center (ARTCC) facility.

2. Press the **small right** knob momentarily to place the cursor on the page.
3. Turn the **large right** knob to highlight the FSS/ARTCC frequency and press **ENT** to place the frequency in the standby field of the COM window.

To select a COM frequency for any airport in your flight plan:

1. Select the NAVCOM page from the NAV page group. (Press and hold the **CLR** key, then turn the **small right** knob until the NAVCOM page appears.)



The NAVCOM page provides a frequency list for all the airports (departure, en route and arrival) along your active flight plan.

2. Press the **small right** knob to place the cursor on the airport identifier field. To the left of this field appears Departure, En Route or Arrival — depending on the placement of the displayed airport within your flight plan.
3. Turn the **small right knob** to display a window listing the airports in your flight plan. Continue turning the **small right** knob to select the desired airport.
4. Press **ENT** to return to the NAVCOM page with the frequencies for the selected airport.
5. Turn the **large right** knob to highlight the desired frequency.
6. Press **ENT** to place the highlighted frequency in the standby COM window field.

To select a COM frequency for any airport in the database:

1. Select the airport frequencies page from the WPT page group. (Turn the **large right** knob to select the WPT page group. Then turn the **small right** knob until the airport frequencies page appears.)



Use the airport frequencies page to retrieve a frequency list for ANY airport in the Jeppesen NavData database.

2. Press the **small right** knob to place the cursor on the airport identifier field.
3. Use the **small** and **large right** knobs to enter the identifier of the desired airport. Press **ENT**

when finished.

4. Turn the **large right** knob to highlight the desired frequency.
5. Press **ENT** to place the highlighted frequency in the standby COM window field.

Emergency Channel

The 420W/430W emergency channel select provides a quick method of selecting 121.500 MHz as the active frequency in the event of an in-flight emergency. The emergency channel select is available whenever the unit is on, regardless of GPS or cursor status, or loss of the display.

To quickly tune and activate 121.500, press and hold the COM (or remote) flip-flop key for approximately two seconds. If the remote key is used, further changes in COM frequency will not be possible without recycling power.



Press and hold the COM flip-flop key for two seconds to activate the 121.500 MHz emergency frequency.



Note: Under some circumstances if the com system loses communication with the main system, the radio will automatically tune to 121.500 MHz for transmit and receive regardless of the displayed frequency.

Stuck Microphone

Whenever the 420W/430W is transmitting, a 'TX' indication will appear in the COM window. If the microphone is stuck or accidentally left in the keyed position, or continues to transmit after the key is released, the COM transmitter will automatically time out (or cease transmitting) after 35 seconds of continuous broadcasting. You'll also receive a "COM push-to-talk key stuck" message as long as the stuck condition exists.



A "COM push-to-talk key stuck" message appears to warn you of a stuck microphone. Transmitting is disabled after 35 seconds of continuous broadcasting.

Remote Frequency Selection Control

On units configured for remote Com frequency recall*, pressing the remote recall switch will load the next preset Com frequency into the unit's Standby frequency box and display a temporary pop-up window with the current Preset ID number—e.g., Preset 1 or Preset 12. The remote recall switch can be pressed multiple times to scroll the entire preset frequency list through the Standby frequency box (the list will “wrap” from the bottom of the list back up to the top, skipping any empty preset positions).

* *Preset Com Frequencies are only available with SW Version 3.00, or later.*

The standby frequency isn't activated until a Com flip flop switch (either remote- or bezel-mounted) is pressed. Remote Frequency Selection only functions on units configured for a remote Com Frequency recall switch. See *Aux Pages - Setup 2 Page - Preset Com Frequencies* for instructions on storing preset Com frequencies.



Section 2 NAV Pages

Main Page Groups

The 400W-series main pages are divided into groups: NAV, WPT, AUX and NRST. While viewing any of these pages, selection of another page is a simple selection process using the **small** and **large right** knobs.

| | |
|--|---|
| NAV 7+ available pages (see list below) | WPT 10 available pages (see Section 6) |
| AUX 4 available pages (see Section 9) | NRST 8 available pages (see Section 7) |

To select the desired page group, turn the large right knob until a page from the desired group is displayed.

To select the desired page within the group, turn the small right knob until the desired page is displayed.

NAV Page Group

The NAV page group includes seven, or more, pages. While viewing any NAV page, turn the **small right** knob to select a different NAV page. You may find this selection process convenient to cycle between the *default NAV* and *map pages*—two of the most frequently used pages. Other pages are provided to list frequencies for your flight plan, show your current position, display current satellite reception, and make vertical navigation settings.



Default NAV



Map

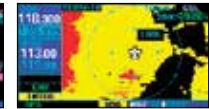

Terrain



NAVCOM



Position



Satellite Status



VNAV



The bottom right corner of the screen indicates which page group is currently being displayed (e.g., NAV or NRST), the number of screens available within that group (indicated by square icons) and the placement of the current screen within that group (indicated by a highlighted square icon). To select a different page within the group, turn the small right knob.

DTK 313° 9 S

LT TO 030° NOW

ARRIVING WPT

HOLD TEARDROP

This part of the screen is also used to display the 400W-series turn advisories (e.g., "DTK 313° 9 S", or LT TO 030° NOW) and waypoint alerts (e.g., "ARRIVING WPT" or "HOLD TEARDROP") during flight plan and approach operations. Seconds will be abbreviated as "S" and Now may be seen as "N". See Section 5 for more information.

2 - NAV PAGES

Default Nav Page

Default NAV Page

The first NAV page is the *default NAV page*. This page may be quickly selected from ANY page by using the **CLR** key.

To select the NAV group and display the default NAV page, press and hold the CLR key.

The *default NAV page* displays a graphic course deviation indicator (CDI) across the top of the page. Unlike the angular limits on a CDI coupled to a VOR or ILS receiver, full scale limits for this CDI are defined by a GPS-derived distance (2.0, 1.0 or 0.3 NM). By default, the CDI scale automatically adjusts to the desired limits based upon the current phase of flight: en route, terminal area or approach.

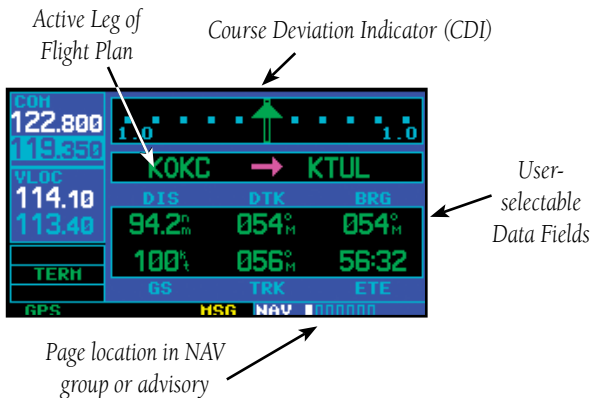









NOTE: Approaching the FAF, the GNS 400W-series unit automatically rescales in an angular fashion. This allows the LPV approach to be flown identically to a standard ILS. At 2.0 NM from the FAF, CDI scaling is tightened from 1.0 to the angular full scale deflection defined for the approach.

You may also manually select the desired scale setting as outlined in the Aux Setup section.

The graphic CDI shows your position at the center of the indicator, relative to the desired course (the moving course deviation needle). As with a traditional mechanical CDI, when you're off course simply steer toward the needle. The TO/FROM arrow in the center of the scale indicates whether you are heading to the waypoint (an up arrow) or if you have passed the waypoint (a down arrow).

The following symbols are used—on the default NAV page directly below the CDI—to depict the "active leg" of a flight plan or direct-to:

-  Direct-To a Waypoint
-  Course to a Waypoint, or Desired Course between Two Waypoints
-  Right Procedure Turn
-  Left Procedure Turn
-  Vectors-To-Final
-  DME Arc to the left
-  DME Arc to the right
-  Left-hand Holding Pattern
-  Right-hand Holding Pattern

Directly below the CDI appears the active leg of your flight plan, or the direct-to destination when using the **direct-to** key. This will automatically sequence to the next leg of your flight plan as you reach each interim waypoint. If no flight plan or direct-to destination has been selected, the destination field will remain blank.

Selecting Desired On-Screen Data

At the bottom of the *default NAV page* you'll find six user-definable fields which display the data you'll need as your flight progresses. By default these fields display: distance to destination (DIS), desired track (DTK), bearing to destination (BRG), ground speed (GS), ground track (TRK) and estimated time en route (ETE). However, each of these fields can be custom-tailored to your preferences by selecting a different data item. Available data items include:

- Bearing to destination (BRG)
- Distance to destination (DIS)
- Desired track (DTK)
- En route safe altitude (ESA)
- Estimated time of arrival (ETA)
- Estimate time en route (ETE)
- Fuel Flow (FLOW) (When Configured)
- Ground speed (GS)
- Minimum safe altitude (MSA)
- Track angle error (TKE)
- Ground track (TRK)
- Vertical speed required (VSR)
- Cross track error (XTK)

If no flight plan or direct-to destination has been selected only speed, track, altitude and minimum safe altitude data may be displayed. All other data types will appear as blank lines—on the *default NAV page*—until a destination is selected.

To select a different data item for any data field:

1. Starting with the default NAV page, press the **MENU** key to display an options menu.
2. The "Change Fields?" option is already highlighted, so press **ENT** to select this option.



3. Use the **large right** knob to highlight the data field you wish to change.

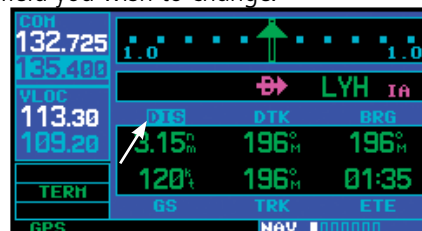

4. Turn the **small right** knob to display the list of available data items. Continue turning the **small right** knob to select the desired data item from the list.



5. Press **ENT** to select the desired data item and return to the default NAV page.
6. Press the **small right** knob momentarily to remove the cursor from the page.

2 - NAV PAGES

Map Page

Restoring Factory Settings

You can also quickly return all data field settings to their original factory settings.

To restore all six data fields to factory default settings:

1. Starting with the default NAV page, press the **MENU** key to display an options menu.
2. Turn the **large right** knob to highlight the “Restore Defaults?” option and press **ENT**.



Dual Unit Considerations

A “Crossfill?” option is provided from the Default NAV Page. This option allows you to transfer a direct-to-destination, the active flight plan including VNAV parameters, any stored flight plan or user waypoints to a second 400W or 500W-series Garmin unit.

See Section 9 - Aux Pages - Flight Planning - Crossfill Operation for additional details on using the “Crossfill?” option.



NOTE: The databases of the 400/500 series and the 400W/500W are incompatible so you may not mix systems.

Map Page

The second NAV page is the map page, which displays your present position using an airplane symbol, along with nearby airports, navaids, user-defined waypoints, airspace boundaries, lakes, rivers, highways and cities.





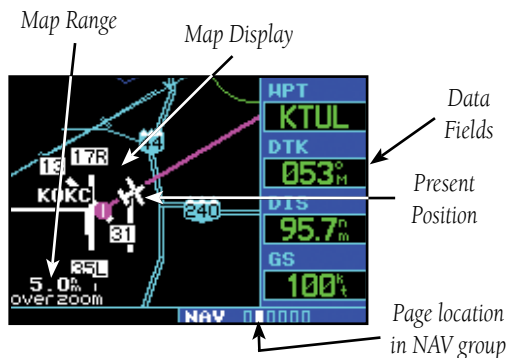









NOTE: The electronic chart is an aid to navigation and is designed to facilitate the use of authorized government charts, not replace them. Land and water data is provided only as a general reference to your surroundings. The positional accuracy of the land and water data is not of a precision suitable for use in navigation and it should not be used for navigation. Only official government charts and notices contain all information needed for safe navigation – and, as always, the user is responsible for their prudent use.



NOTE: If the 400W-series unit is unable to determine a GPS position, the present position (airplane) symbol will appear on the Map Page in yellow. No symbol will be present when there is no active flight plan.

Map Symbols

Various symbols are used to distinguish between waypoint types. The identifiers for any on-screen waypoints can also be displayed. (By default the identifiers are enabled). Special-use and controlled airspace boundaries appear on the map, showing the individual sectors in the case of Class B or Class C airspace. The following symbols are used to depict the various airports and nav aids on the *map page*:

| | | | |
|---|---|---|----------------------|
|  | Airport with hard surface runway(s); Primary runway shown |  | Intersection |
|  | Airport with soft surface runway(s) only |  | VORTAC |
|  | Private Airfield |  | TACAN |
|  | VOR |  | NDB |
|  | VOR/DME |  | Locator Outer Marker |
|  | DME | | |
|  | Localizer | | |
|  | Heliport | | |

Map Range

The map display can be set to 23 different scale settings from 500 feet to 2000 NM (statute and metric units are also available). The scale is indicated in the lower left-hand corner of the map display, and represents the top-to-bottom distance covered by the map display.

To select a map Range:

1. Press the **up arrow** side of the **RNG** key to zoom out to a larger map area.
2. Press the **down arrow** side of the **RNG** key to zoom in to a smaller map area and more detail.



Map Page Auto Zoom

An autozoom feature is available which will automatically adjust from an en route range of 200 NM through each lower range, stopping at a range of 1.0 NM as you approach your destination waypoint. The autozoom feature is turned on/off from the map setup page.

The *map page* also displays a background map showing lakes, rivers, coastlines, highways, railways and towns. When a map scale is selected below the lower limit at which the map detail was originally created, an “overzoom” indication will appear on the map display, below the scale reading. “Overzoom” indicates that the detail at this scale may not accurately represent actual conditions. If you continue to zoom in to lower scale settings, “overzoom” will be replaced with “no map” and the geographic detail is removed from the map display (but, the airport and navaid detail will remain).

The “Setup Map?” option allows you to define the maximum scale at which each map feature will appear. This provides you with complete control to minimize screen clutter. You can also quickly remove items from the map using the **CLR** key.

To quickly declutter the map display, press the CLR key momentarily (as often as needed) to select the desired amount of map detail.

The right-hand side of the map page includes four user-selectable data fields. By default, the displayed data is: destination waypoint name (WPT), desired track (DTK), distance to destination waypoint (DIS) and ground speed (GS). Any of these data fields may be changed to display a different data type. You may also remove the four data fields from the map to show a larger map image.

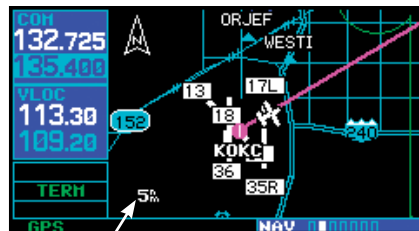

The CLR key allows you to quickly declutter the map display, providing four levels of map detail. Note the “-1” and “-2” (“-3” is also provided) suffix designations above, indicating each successive declutter level.

| Declutter Level | Detail |
|-----------------|---|
| -1 | Removes all land data except rivers and lakes. |
| -2 | Removes all airspace except Prohibited and Restricted. Also removes NDBs, Intersections, and User waypoints. |
| -3 | Removes all data except the Active Flight Plan, Prohibited airspace, rivers, lakes, traffic, and lightning data (also equivalent to “-A” approach mode decluttering). |

Map Panning

Panning allows you to move the map beyond its current limits without adjusting the map range. When you select the panning function — by pressing the **small right** knob — a target pointer will flash on the map display. A window will also appear at the top of the map display showing the latitude/longitude position of the pointer, plus the bearing and distance to the pointer from your present position.

To select the panning function and pan the map display:

1. Press the **small right** knob to activate the panning target pointer.



2. Turn the **small right** knob to move up (turn clockwise) or down (counterclockwise).



3. Turn the **large right** knob to move right (turn clockwise) or left (counterclockwise).
4. To cancel the panning function and return to your present position, press the **small right** knob.

When the target pointer is placed on an object, the name of that object will be highlighted (even if the name wasn't originally displayed on the map). This feature applies to airports, nav aids, user-created waypoints, roads, lakes, rivers — almost everything displayed on the map except route lines.

When an airport, nav aid, or user waypoint is selected on the map display, you can review information about the waypoint or designate the waypoint as your direct-to destination.

To review information for an on-screen airport, nav aid or user waypoint:

1. Use the panning function (as described above) to place the target pointer on a waypoint.
2. Press **ENT** to display the waypoint information page(s) for the selected waypoint.

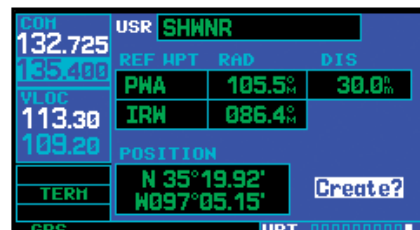

3. Press **CLR** to exit the information page(s).

Map Direct-To

To designate an on-screen airport, navaid or user waypoint as your direct-to destination:

1. Use the panning function (see previous page) to place the target pointer on a waypoint.
2. Press **direct-to** key to display the select direct-to waypoint page, with the selected waypoint already listed.

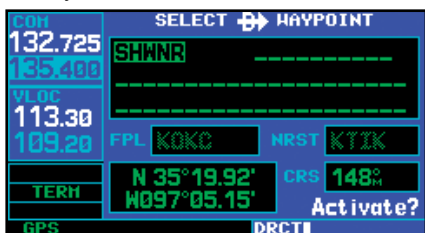

3. Press **ENT** twice to confirm the selection and begin navigating to the waypoint.

The direct-to function can be used anywhere on the map. If nothing currently exists at the crosshair position, a new waypoint (called “+MAP”) will be created at the target pointer location before the direct-to is initiated.

Airspace Information on the Map

When a special-use or controlled airspace boundary appears on the map display, you can quickly retrieve information — such as floor/ceiling limits and controlling agency — directly from the map.

To view airspace information for an on-screen special-use or controlled airspace:

1. Use the panning function (see previous page) to place the target pointer on an open area within the boundaries of an airspace. If the area is congested and it is difficult to select an open area, you may need to zoom in or press **CLR** to make the selection easier.



2. Press **ENT** to display an options menu.
3. “Review Airspace?” should already be highlighted, if not select it with the **small right** knob. Press **ENT** to display the airspace information page for the selected airspace.

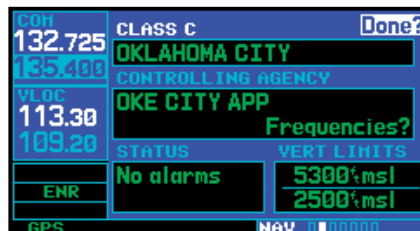

To display airspace frequencies:

1. While viewing the airspace information display in the above example, turn the **large right** knob to highlight “Frequencies?” and press **ENT**. Press **CLR** to return to the airspace information page.
2. Press **CLR** to exit the airspace information page. Press the **small right** knob (**CRSR**) to exit panning.

Map Page Options

Many of the 400W-series functions are menu driven. Each of the main pages has an options menu, allowing you to custom tailor the corresponding page to your preferences and/or select special features which specifically relate to that page. A *map page options menu* provides additional settings to customize the **map page** and additional features related specifically to the *map page*.

To display the map page options menu, press MENU (with the map page displayed).

The following options are available: “Setup Map?”, “Measure Dist?”, “Data Fields Off?”, “Change Fields?” and “Restore Defaults?”.

Map Setup

“Setup Map?” allows you to configure the map display to your preferences, including map orientation, land data enable/disable, Jeppesen data enable/disable, automatic zoom, airspace boundaries, and text size. The following table lists the group names and available settings:

| Feature | Description |
|----------|---|
| Map | Orientation, AutoZoom, Land Data, Aviation Data |
| Weather* | Lightning Mode/Symbol (when applicable) |
| Traffic* | Traffic Mode/Symbol/Label (when applicable) |
| Airport | Large/Medium/Small Airports and Text |
| NAVAID | VORs, NDBs, Intersections and Text |
| Waypoint | User Waypoints, Flight Plan Wpts, and Text |
| Line | Active Flight Plan/Direct-To, Lat/Long Grid |
| Control | Controlled Airspace: Class B, C, D (tower zone) |

| Feature | Description |
|----------|---|
| Airspace | Special-Use Airspace: Restricted, MOA, Other, (TFR, if GDL 69 equipped) |
| City | Large/Medium/Small Cities and Text |
| Road | Freeway, National Highway, Local Hwy, Local Road |
| Other | States/Prov, Rivers/Lakes, Railroads, Wind Vector |

* Weather and Traffic settings are only available when the 400W-series unit installation includes connection to traffic and/or weather information sources. See 400W/500W Series Display Interfaces Pilot’s Guide Addendum.



Large, Medium and Small classifications are used on the 400W-series for airports and cities. Large airports are those with a runway longer than 8100 feet. Medium airports include those with a runway longer than 5000 feet or with a control tower. Large cities are those with approximate populations greater than 200,000 and Medium cities are greater than 50,000.

2 - NAV PAGES

Map Page Options

To change a map setup feature:

1. On the Map page, press **MENU** to bring up the Page Menu. Then, turn the **large right** knob to highlight "Setup Map?" and press **ENT**.
2. To change map orientation, turn the **small right** knob to select "Map" and press **ENT**.

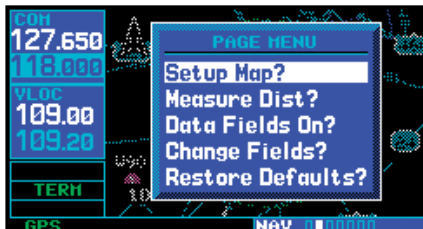

3. Turn the **large right** knob to highlight the "Orientation" field and turn the **small right** knob to select the desired option. Select "North up" to fix the top of the map display to a north heading. Select "Track up" to adjust the top of the map display to your current track heading.

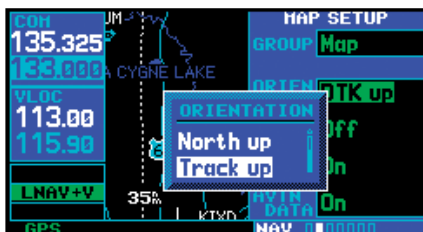

Select "DTK up" to fix the top of the map display to your desired course. Press **ENT** to accept the selected option.

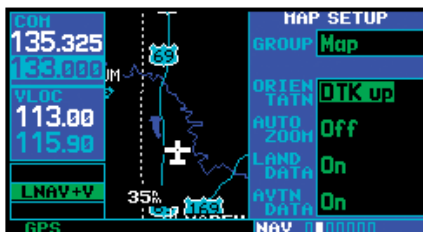

4. To enable/disable automatic zoom, turn the **small right** knob to select "Map" and press **ENT**. Turn the **large right** knob to highlight the "Auto Zoom" field and turn the **small right** knob to select "On" or "Off". Press **ENT** to accept the selected option. The automatic zoom feature will automatically adjust the map scale from 2000 NM through each lower scale, stopping at 1.0 NM as you approach your destination waypoint.
5. To enable/disable background land data, or all Jeppesen aviation data, turn the **small right** knob to select "Map" and press **ENT**. Use the **large right knob** to highlight the appropriate field and turn the **small right** knob to select "On" or "Off". Press **ENT** to accept the selected option.
6. For airports, NAVAIDs, active flight plan waypoints, user-created waypoints, state/provincial boundaries, rivers/lakes and cities: turn the **small right** knob to select the appropriate "Group" name (per the chart on the previous page) and press **ENT**. Use the **large right** knob to highlight the zoom field for the desired feature and turn the **small right** knob to select the maximum scale at which the feature should appear on screen. Or select "Off" to never display the selected feature. Press **ENT** to accept the selected option. Next, turn the **large right** knob to highlight the text field for the desired feature and turn the **small right** knob to select the desired text size, or select "None" to disable text descriptions. Press **ENT** to accept the selected option.

- For airspace boundaries, highways, roads, rail-road lines, wind vector, active flight plan course lines, and lat/long grid lines: turn the **small right** knob to select the appropriate "Group" name (per the chart on the previous page) and press **ENT**. Use the **large right** knob to highlight the zoom field for the desired feature and turn the **small right** knob to select the maximum scale at which the feature should appear on screen. Or select "Off" to never display the selected feature. Press **ENT** to accept the selected option. Distance Measurements

The "Measure Dist?" option provides a quick, easy method for determining the bearing and distance between any two points on the map display.

To measure bearing and distance between two points:

- On the Nav Map page, press **MENU**. Then, turn the **large right** knob to highlight "Measure Dist?" and press **ENT**. An on-screen reference pointer will appear on the map display at your present position.

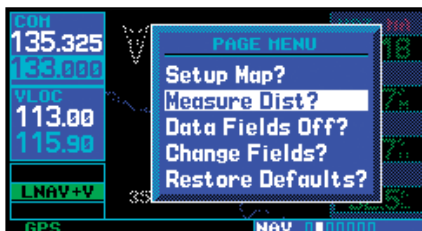

- Use the **small** and **large right** knobs to place the reference pointer at the location you wish to measure FROM and press **ENT**.
- Again, use the **small** and **large right** knobs to place the reference pointer at the location you wish to measure TO. The bearing and distance from the first reference location will appear at the top of the map display.



- To exit the "Measure Dist?" option, press the **small right** knob.

Data Fields on the Map

The “Data Fields Off?” option provides a full-screen map display (shown bottom right), without the four data fields along the right-hand side of the screen. Select this option when you wish to display a larger map area. If this option has been selected and the data fields are off, “Data Fields On?” will appear as an option instead.

To turn the data fields on or off, press **MENU** and turn the **large right knob** to highlight “Data Fields Off?” (or “Data Fields On?”), then press **ENT**.

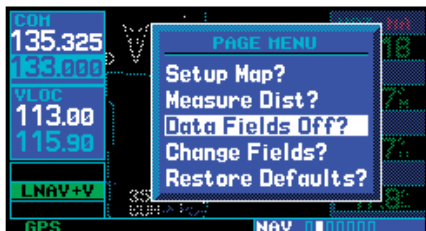

Selecting Desired On-Screen Data

“Change Fields?” allows you to choose the data displayed on the four user-selectable data fields along the right-hand side of the *map page*. There are twelve available data types, including bearing to destination, distance to destination, estimated time of arrival, ground speed, minimum safe altitude and track. See Section 11 for descriptions of these (and other) navigation terms.

To change a data field:

1. Press **MENU** on the Map page and then turn the **large right knob** to highlight “Change Fields?”. Then, press **ENT**.



2. Turn the **large right knob** to highlight the data field you wish to change.
3. Turn the **small right knob** to select the type of data you want to appear on this field and press **ENT**.



4. Press the **small right knob** to remove the cursor.



NOTE: The on-screen traffic information will occupy two data fields, leaving room to display only two additional data types. Traffic information is only available when the 400W-series installation includes connection to traffic information sources. See the 400W Series Pilot’s Guide Addendum, part number 190-00356-31.

Restoring Factory Settings

“Restore Defaults?” resets all four user-selectable data fields to their original factory default settings.

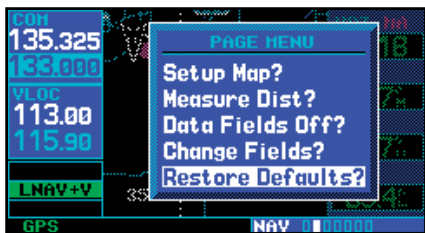

To restore the factory default settings, press MENU and turn the large right knob to highlight “Restore Defaults?”, then press ENT.

Terrain Operation

During power-up of the 400W Series unit, the terrain/obstacle database versions are displayed along with a disclaimer. At the same time, the Terrain system self-test begins. A failure message is issued if the test fails.

Garmin TERRAIN is a non-TSO-C151b-certified terrain awareness system provided as a standard feature of 400W-Series units to increase situational awareness and help reduce controlled flight into terrain (CFIT).

For units with installed in helicopters or equipped with optional HTAWS, refer to 400W/500W Series Garmin Optional Displays, P/N 190-00356-30 Rev G, or later.

Operating Criteria

TERRAIN requires the following to operate properly:

- The system must have a valid 3-D GPS position solution.
- The system must have a valid terrain/obstacle/airport terrain database.

Terrain Limitations

TERRAIN displays terrain and obstructions relative to the altitude of the aircraft. The displayed alerts are advisory in nature only. Individual obstructions may be shown if available in the database. However, all obstructions may not be available in the database and data may be inaccurate. Never use this information for navigation or to maneuver to avoid obstacles.

Terrain information is based on terrain elevation information in a database that may contain inaccuracies. Terrain information should be used as an aid to situational awareness. Never use it for navigation or to maneuver to avoid terrain.

TERRAIN uses terrain and obstacle information supplied by government sources. The data undergoes verification by Garmin to confirm accuracy of the content, per TSO-C151b. However, the displayed information should never be understood as being all-inclusive.



NOTE: The data contained in the TERRAIN databases comes from government agencies. Garmin accurately processes and cross-validates the data but cannot guarantee the accuracy and completeness of the data.

TERRAIN Alerting

TERRAIN uses information provided from the GPS receiver to provide a horizontal position and altitude. GPS altitude is derived from satellite measurements. GPS altitude is converted to a mean sea level (MSL)-based altitude (GSL altitude) and is used to determine TERRAIN alerts. GSL altitude accuracy is affected by factors such as satellite geometry, but it is not subject to variations in pressure and temperature that normally affect pressure altitude devices. GSL altitude does not require local altimeter settings to determine MSL altitude. Therefore, GPS altitude provides a highly accurate and reliable MSL altitude source to calculate terrain and obstacle alerts.

TERRAIN utilizes terrain and obstacle databases that are referenced to mean sea level (MSL). Using the GPS position and GSL altitude, TERRAIN displays a 2-D picture of the surrounding terrain and obstacles relative to the position and altitude of the aircraft. Furthermore, the GPS position and GSL altitude are used to calculate and “predict” the aircraft’s flight path in relation to the surrounding terrain and obstacles. In this manner, TERRAIN can provide advanced alerts of predicted dangerous terrain conditions. Detailed alert modes are described later in this section.

Baro-Corrected Altitude

Baro-corrected altitude (or indicated altitude) is derived by adjusting the altimeter setting for local atmospheric conditions. The most accurate baro-corrected altitude can be achieved by frequently updating the altimeter setting to the nearest reporting station along the flight path. However, because actual atmosphere conditions seldom match the standard conditions defined by the International Standard Atmosphere (ISA) model (where

pressure, temperature, and lapse rates have fixed values), it is common for the baro-corrected altitude (as read from the altimeter) to differ from the GPS-MSL altitude. This variation results in the aircraft’s true altitude differing from the baro-corrected altitude.

Terrain Page

To display the TERRAIN Page, select the NAV group and turn the **small right** knob until the TERRAIN Page is displayed. The page displays terrain information, aircraft ground track, and GPS-derived MSL altitude (GSL altitude). Altitude is shown in increments of 20 feet or in increments of 10 meters, depending on unit configuration.

The TERRAIN Page has two selectable view settings:

- **360° View**—View from above aircraft depicting surrounding terrain on all sides
- **120° View**—View of terrain ahead of and 60° to either side of the aircraft flight path

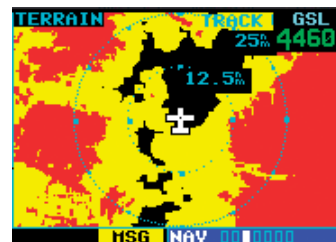

TERRAIN Page



NOTE: The TERRAIN Page gives a “Track Up” display orientation, as indicated by the “TRK” label shown on the display. This is the only orientation available on this page.

To display a 120° view:

1. Select the TERRAIN Page and press **MENU**.
2. Select "View 120°?".
3. Press **ENT**. To switch back to a 360° view, repeat step 1, select "View 360°?", and press **ENT**.

Seven display ranges are available, allowing for a more complete view of the surrounding area.

To change the display range:

1. Select the TERRAIN Page and press up or down on the **RNG** key to select the desired range: 1 NM, 2 NM, 5 NM, 10 NM, 25 NM, 50 NM, 100 NM.

Aviation information such as airports, VORs, and other nav aids can be turned on or off from the TERRAIN Page.

To show or hide aviation data:

1. Select the TERRAIN Page and press **MENU**.
2. Select "Show (or Hide) Aviation Data" and press **ENT**. Pressing the **CLR** key when the TERRAIN Page is displayed will also toggle aviation information on or off.



Inhibit Mode

The Garmin TERRAIN system provides an "inhibit mode". This mode is designed to deactivate Premature Descent Alert/Forward Looking Terrain Avoidance (PDA/FLTA) visual alerts when they are deemed unnecessary by the pilot. Flying VFR into an area where unique terrain exists could cause the system to annunciate a nuisance alert. Pilots should use discretion when inhibiting the TERRAIN system and always remember to enable the system when appropriate. When terrain is inhibited, the Terrain page will still be active, but alerts and messages will not be generated. See the Terrain Alerts section for more information on terrain alerts.

TERRAIN configured units will restore the "inhibit state" at startup to the last pilot-selected setting.

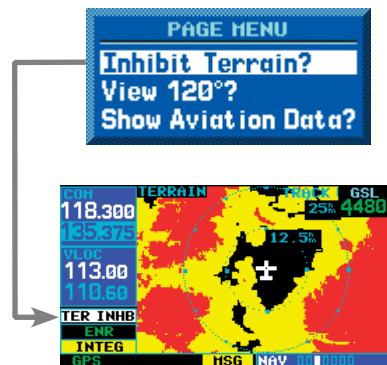

Inhibiting Terrain

To inhibit TERRAIN:

1. Select the TERRAIN Page and press **MENU**. "Inhibit Terrain?" is selected by default.
2. Press **ENT**. The TERRAIN system is inhibited. The **TER INHB** annunciation is displayed in the terrain annunciator field whenever terrain is inhibited.

To enable TERRAIN:



Enabling Terrain

1. Select the TERRAIN Page and press **MENU**. "Enable Terrain?" is selected by default.
2. Press **ENT**. The TERRAIN system is functional again.

Terrain Symbols

The symbols shown below are used to represent obstacles and potential impact points on the Terrain Page. Note that obstacle symbols are shown on display zoom ranges up to 10 NM:

The Garmin TERRAIN system uses yellow (caution) and red (warning) to depict terrain information relative to aircraft altitude. Each color is associated with an alert severity level. Terrain graphics and visual annunciations also use these color assignments.



NOTE: If an obstacle and the projected flight path of the aircraft intersect, the display automatically zooms in to the closest potential point of impact on the TERRAIN page.

| Obstacle Symbol | Unlighted Obstacle | | Lighted Obstacle | | Color (Alert Level) | TERRAIN/Obstacle Location |
|-----------------|--------------------|-------------|------------------|-------------|-------------------------|---|
| | < 1000' AGL | > 1000' AGL | < 1000' AGL | > 1000' AGL | | |
| | | | | | Red (Warning) | Terrain/Obstacle above or within 100 ft below current aircraft altitude |
| | | | | | Yellow (Caution) | Terrain/Obstacle between 100 ft and 1000 ft below the aircraft altitude |

Terrain Color Symbology

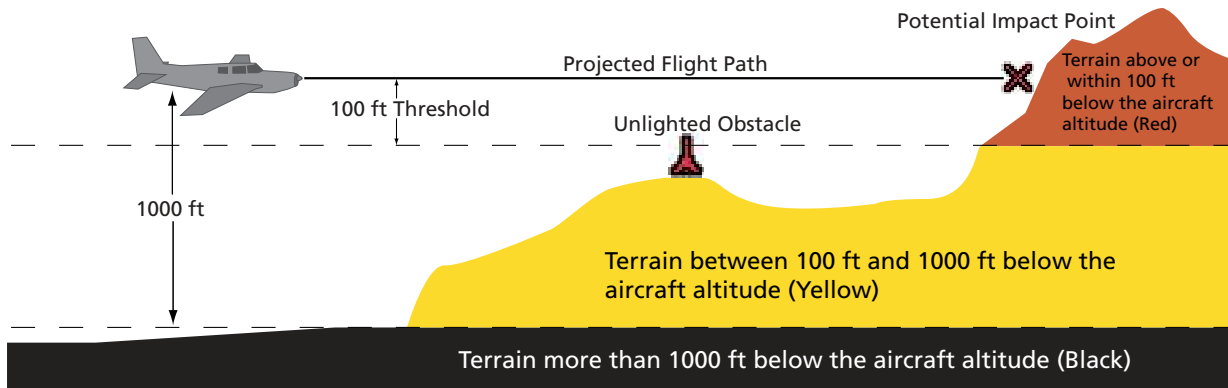

TERRAIN Altitude/Color Correlation

General Database Information

The Garmin TERRAIN system uses terrain and obstacle information supplied by government sources. The data undergoes verification by Garmin to confirm accuracy of the content, per TSO-C151b. **However, the information displayed should never be understood to be all-inclusive. Pilots must familiarize themselves with the appropriate charts for safe flight.**



NOTE: The data contained in the terrain and obstacle databases comes from government agencies. Garmin accurately processes and cross-validates the data, but cannot guarantee the accuracy and completeness of the data.

The terrain/obstacle databases are contained on a datacard which is inserted in the right-most slot of the 400W Series units.

Database Versions

The version and area of coverage of each terrain/obstacle database is shown on the Terrain Database Versions Page, located in the AUX Page Group. Databases are checked for integrity at power-up. If a database is missing or corrupt, the TERRAIN system will fail the self-test and issue a failure message.

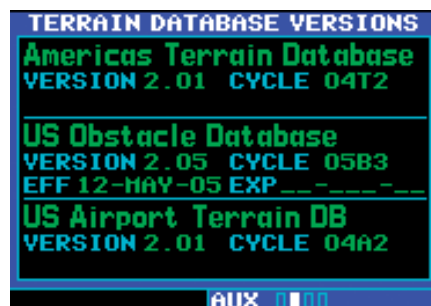
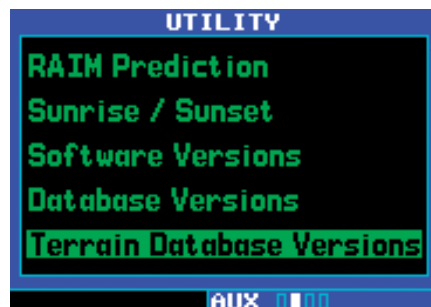

TERRAIN Database Information

Database Updates

Terrain/Obstacle databases are updated periodically with the latest terrain and obstacle data. Visit the Garmin website to check for newer versions of terrain/obstacle databases. Compare database cycle numbers to determine if a newer version is available.

The database update process includes either reprogramming or replacing the database card and inserting the updated card in the right card slot on the unit front panel. The terrain/obstacle database may be downloaded via the internet and the card reprogrammed using a USB programmer available from Garmin. Contact Garmin at 800-800-1020 or at www.garmin.com for more information.

To update the terrain or obstacle database:

1. Acquire a new terrain data card from Garmin.
2. Turn off the power to the 400W Series unit.
3. Remove the old terrain data card from and insert the new card into the right-most slot of the 400W Series unit.
4. Turn on the 400W Series unit and verify that the TERRAIN system passes the self-test. The "TER TEST" annunciator will clear after checking and no failure message appears.

Terrain/Obstacle Database Areas of Coverage

The following describes the area of coverage available in each database. Regional definitions may change without notice.

| Database | Coverage Area |
|--------------------|--|
| Worldwide (WW) | Latitudes: N 75° to S 60° Longitudes: W 180° to E 180° |
| United States (US) | Limited to the United States plus some areas of Canada, Mexico, Caribbean, and the Pacific. |
| US/Europe | Alaska, Austria, Belgium, Canada*, Caribbean*, Czech Republic, Denmark, Estonia, Finland, France, Germany, Greece, Hawaii, Iceland, Ireland, Italy, Latvia, Lithuania, Mexico*, Netherlands, Norway, Poland, Portugal, Slovakia, Spain, Sweden, Switzerland, United Kingdom, United States |

* Indicates partial coverage



CAUTION: Obstacles 200 feet and higher are included in the Obstacle Database. It is very important to note that not all obstacles are necessarily charted and therefore may not be contained in the Obstacle Database.

Navigation Database

It is therefore important to also have the latest Navigation Database installed to ensure correct Terrain alerting.

TERRAIN Alerts

TERRAIN alerts are issued when flight conditions meet parameters that are set within the TERRAIN system software algorithms. When an alert is issued, visual annunciations are displayed. Annunciations appear in a dedicated field in the lower left corner of the display.

TERRAIN Annunciation Field TERRAIN Pop-Up Alert

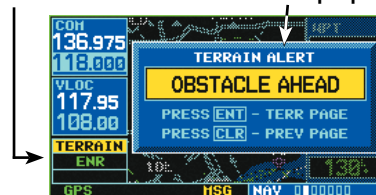

TERRAIN Annunciation and Pop-Up Alert

Pop-up Alerts

On any page except the TERRAIN Page, when a terrain or obstacle alert is issued, a pop-up window is displayed with the appropriate alert.

To acknowledge the pop-up alert and return to the currently viewed page:

Press the **CLR** key.

To acknowledge the pop alert and quickly display the TERRAIN Page:

Press the **ENT** key.

Forward Looking Terrain Avoidance

The unit will issue terrain alerts not only when the aircraft altitude is below the terrain elevation but also when the aircraft is projected to come within minimum clearance values of the terrain. This alerting, called Forward Looking Terrain Avoidance (FLTA), is also provided for obstacles. Any potential impact points will be depicted on the display.

FLTA Severity Levels



TERRAIN

"TERRAIN ADVISORY" advisory—Similarly, an "OBSTACLE ADVISORY" alert is also provided.



TERRAIN

"TERRAIN AHEAD" alert (flashing)—Similarly, an "OBSTACLE AHEAD" alert is also provided.



Minimum Terrain Clearance Values

NOTE: During the final approach phase of flight, FLTA alerts are automatically inhibited when the aircraft is below 200 feet AGL while within 0.5 NM of the approach runway or is below 125 feet AGL while within 1.0 NM of the runway.

| Phase of Flight | Level Flight | Descending |
|-----------------|--------------|------------|
| En Route | 700 ft. | 500 ft. |
| Terminal | 350 ft. | 300 ft. |
| Approach | 150 ft. | 100 ft. |
| Departure | 100 ft. | 100 ft. |

2 - NAV PAGES

Terrain Alerts

Premature Descent Alerting (PDA)

The TERRAIN system issues a Premature Descent Alert (PDA) when the system detects that the aircraft is significantly below the normal approach path to a runway.



PDA ends when the aircraft is either:

- 0.5 NM from the runway threshold
- OR
- is below an altitude of 125 feet AGL while within 1.0 NM of the threshold.

PDA Severity Levels



TERRAIN

CAUTION — The above annunciation and pop-up terrain alert are displayed during a PDA alert.

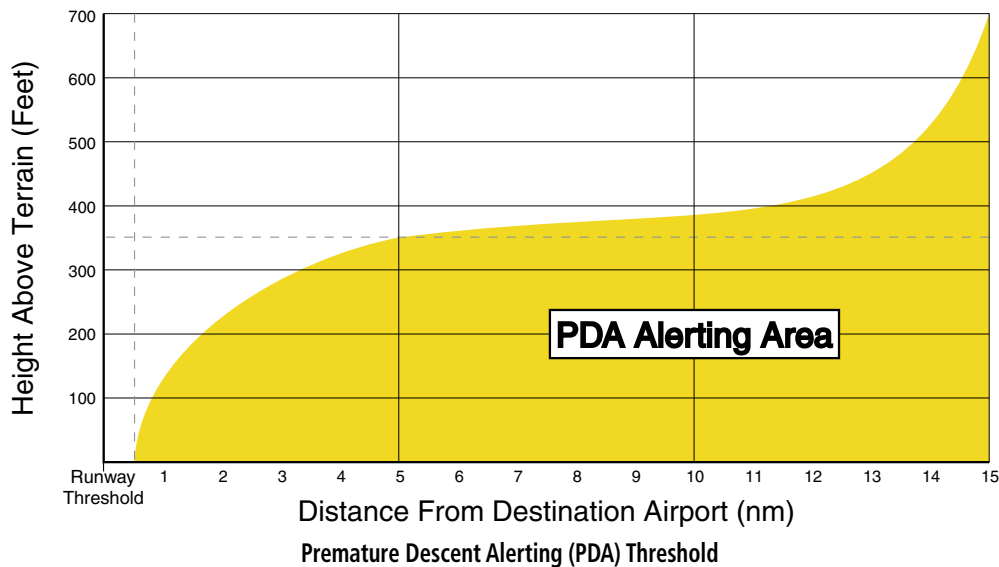

TERRAIN Failure Alert

The TERRAIN system continually monitors several system-critical items, such as database validity, hardware status, and GPS status. Should the system detect a failure, a message is annunciated “TERRAIN has failed”.



“TERRAIN has failed” message

“TERRAIN Not Available” Alert

The TERRAIN system requires a 3D GPS navigation solution along with specific vertical accuracy minimums. Should the navigation solution become degraded, or if the aircraft is out of the database coverage area, the annunciation “TERRAIN NOT AVAILABLE” is displayed on the TERRAIN Page.



“TERRAIN NOT AVAILABLE” display

2 - NAV PAGES

Terrain Alerts

| Annunciation | Pop-Up Alert | Description |
|-------------------------------|-------------------------------------|--|
| TER FAIL | None | TERRAIN has failed |
| TER INHB | None | TERRAIN has been inhibited |
| TER N/A | None | TERRAIN not available due to degraded navigation solution or the aircraft is outside of the database coverage area. |
| TERRAIN | TERRAIN ADVISORY | Terrain FLTA advisory generated by predicted or present aircraft altitude being below minimum clearance values. Unless there is a change in conditions a TERRAIN AHEAD alert may be generated. |
| TERRAIN (FLASHING) | TERRAIN AHEAD (FLASHING) | Terrain FLTA alert generated by predicted or present aircraft altitude being below minimum clearance values. |
| TERRAIN | CAUTION - OBSTACLE | Obstacle FLTA advisory generated by predicted or present aircraft altitude being below minimum clearance values. Unless there is a change in conditions a OBSTACLE AHEAD alert may be generated. |
| TERRAIN (FLASHING) | OBSTACLE AHEAD (FLASHING) | Obstacle FLTA alert generated by predicted or present aircraft altitude being below minimum clearance values. |
| TERRAIN | TOO LOW - TERRAIN | PDA alert when the aircraft is significantly below the normal approach path to the runway. |
| TERRAIN Alerts Summary | | |

NAVCOM Page

The NAVCOM (*navigation communications*) page provides a list of the airport communication and navigation frequencies at your departure, en route and arrival airports. The NAVCOM page makes selection of the frequencies you'll need along your flight plan quick and convenient. If you do not have an active flight plan with a departure airport, the NAVCOM page will display the frequencies for the airport nearest your departure position. Only the 420AW and 430AW move frequencies to their Navcom.

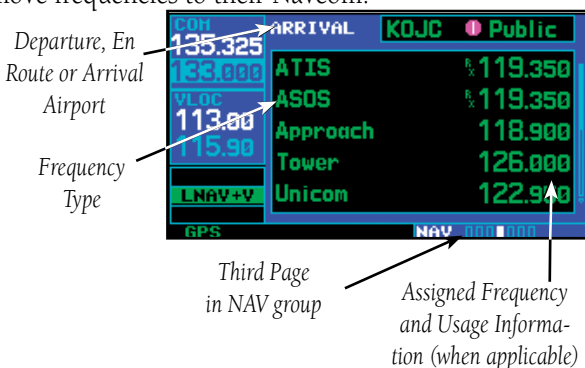

To select a frequency list for a departure, en route, or arrival airport:

1. Press the **small right** knob to activate the cursor.
2. Turn the **large right** knob to place the cursor on the airport identifier field (top line on the NAVCOM page).



3. Turn the **small right** knob to select the desired airport and press **ENT**.



To scroll through the list of frequencies:

1. Activate the cursor, if not already active, by pressing the **small right** knob.
2. Turn the **large right** knob to move the cursor through the list of frequencies. If there are more frequencies in the list that can be displayed on the screen, a scroll bar along the right-hand side of the screen will indicate which part of the list is currently being displayed.



3. To place a frequency in the standby field of the COM or VLOC window, highlight the desired frequency and press **ENT**. (420AW and 430AW only)



2 - NAV PAGES

Position Page

Some listed frequencies may include designations for limited usage, as follows:

- “TX” - transmit only
- “RX” - receive only
- “PT” - part time frequency

If a listed frequency has sector or altitude restrictions, the frequency will be preceded by an “Info?” designation.

To view usage restrictions for a frequency:

1. Turn the **large right** knob to place the cursor on the “Info?” designation directly in front of the desired frequency.
2. Press **ENT** to display the restriction information.



3. To return to the NAVCOM page, press **ENT**.

Position Page

The *position page* displays your present position (by default, in latitude and longitude) and altitude. The *position page* also displays your current track, ground speed, time and a reference waypoint field. These fields are user-selectable to configure the page to your own preferences and current navigation needs.

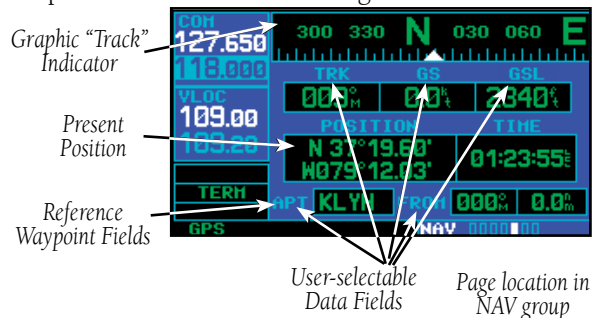

The graphic “track” indicator at the top of the page indicates the direction you’re heading, or track, only while you’re moving. Directly below are three user-selectable fields, which by default, display track, ground speed and altitude. Minimum safe altitude (MSA) can also be displayed on these fields. MSA is the recommended minimum altitude within approximately ten miles of your present position. MSA is calculated from the information contained in the database and generally includes mountains, buildings and other permanent features.

The Time and other data may not be displayed until the unit has acquired enough satellites for a fix.

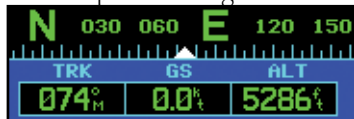

The graphic “track” indicator and the TRK indication directly below it provide the same information. Use the graphic “track” indicator for quick at-a-glance ground track information.



NOTE: Do not rely solely on MSA as an absolute measure of safe altitude. Consult current charts and NOTAMs for your area.

To change the user-selectable data fields:

1. Press **MENU** to display the Position page options menu.
2. Turn the **large right** knob to highlight “Change Fields?” and press **ENT**.



3. Turn the **large right knob** to highlight the data field you wish to change.

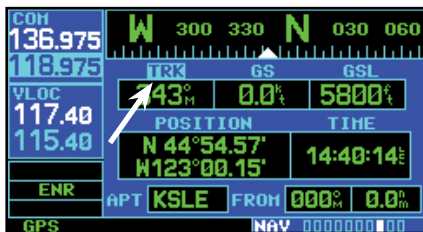

4. Turn the **small right** knob to display the list of available data items. Continue turning the **small right** knob to select the desired data item from the list.



5. Press **ENT** to select the desired data item and return to the position page.

6. Press the **small right** knob momentarily to remove the cursor from the page.

The position page also features a reference waypoint field, located at the bottom of the page, to indicate your bearing and distance to/from a selected waypoint. The reference waypoint field can display bearing and distance information for a nearby airport (default), VOR, NDB, intersection or user waypoint.

To change the reference waypoint information:

1. Press **MENU** to display the position page options menu.
2. Turn the **large right** knob to highlight “Change Fields?” and press **ENT**.
3. Turn the **large right** knob to highlight the waypoint type field (bottom left corner of the page; default setting will show “APT”).
4. Turn the **small right** knob to display the list of available waypoint types. Continue turning the **small right** knob to select the desired data item from the list.



5. Press **ENT** to select the desired type and return to the position page.
6. To select between “bearing FROM” or “bearing TO” to the reference waypoint, turn the **small right** knob to select the desired bearing reference and press **ENT**.

2 - NAV PAGES

Restoring Factory Settings



7. Press the **small right** knob momentarily to remove the cursor from the page.
8. If “WPT” is selected as the waypoint type, you can designate any airport, NAVAID or user waypoint as a reference waypoint. Press the **small right** knob, turn the **large right** knob to highlight the waypoint identifier field, then use the **small and large right knobs** to enter the identifier of the desired waypoint. Press **ENT** to confirm the selected waypoint. Press the **small right** knob to remove the cursor.

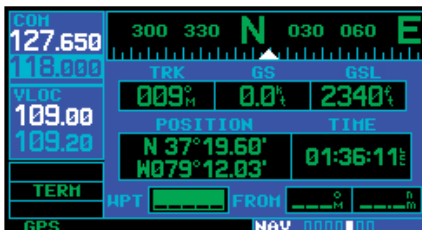

Restoring Factory Settings

A “Restore Defaults?” option allows you to reset all data fields to their original factory default settings. This will return the three user-selectable fields at the top of the page AND the reference waypoint fields to default settings.

To restore the factory default settings:

1. Press **MENU** to display the position page options menu.
2. Turn the **large right** knob to highlight “Restore Defaults?” and press **ENT**.

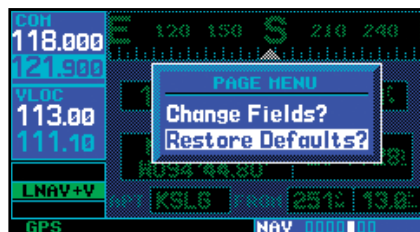

Satellite Status Page

The Satellite Status Page is helpful in troubleshooting weak (or missing) signal levels due to poor satellite coverage or installation problems. You may wish to refer to this page occasionally to monitor GPS receiver performance and establish a normal pattern for system operation. Should problems occur at a later date, you may find it helpful to have an established baseline from which to compare.

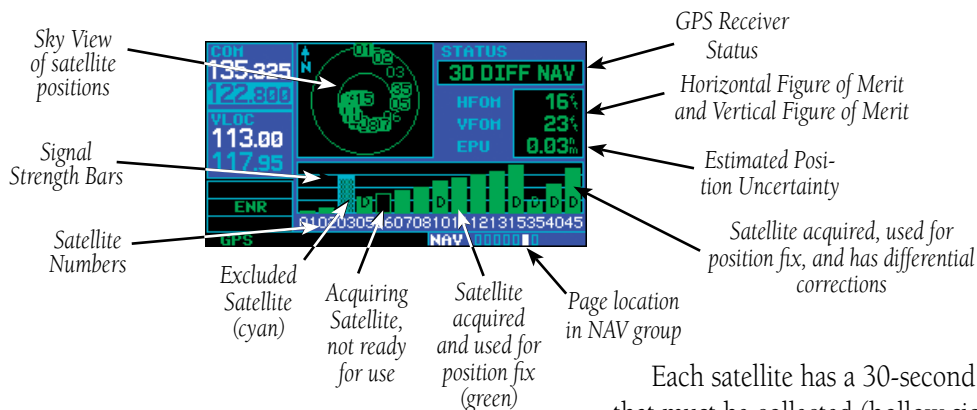

As the GPS receiver locks onto satellites, a signal strength bar appears for each satellite in view, with the appropriate satellite number (01-32, WAAS satellites will have higher numbers) underneath each bar. The progress of satellite acquisition is shown in the following conditions:

- Hollow signal strength bars — the receiver has found the satellite(s) and is collecting data.
- Cross-hatch cyan signal strength bars — the receiver has found the satellite(s) but it has been excluded by the FDE program as a faulty satellite.
- Solid cyan signal strength bars — the receiver has collected the necessary data, but is not using the satellite in the position solution.
- Solid green signal strength bars — the receiver has collected the necessary data and the satellite is being used in the position solution. The sky view display

(at top left corner of the page) shows which satellites are currently in view, and where they are. The outer circle of the sky view represents the horizon (with north at top of the page); the inner circle 45° above the horizon; and the center point directly overhead.

The “D” character inside the bars indicates differential corrections (e.g. WAAS) are being used for that satellite.

Each satellite has a 30-second data transmission that must be collected (hollow signal strength bar) before the satellite may be used for navigation (solid signal strength bar). Once the GPS receiver has determined your position, the 400W-series unit indicates your position, altitude, track and ground speed. The GPS receiver status field also displays the following messages under the appropriate conditions:

- Searching Sky — The GPS receiver is searching the sky for ANY visible satellites. You are also informed of this status with a “Searching the Sky” message.
- Acquiring Sat — The GPS receiver is acquiring satellites for navigation. In this mode, the receiver uses satellite orbital data (collected continuously from the satellites) and last known position to determine the satellites that should be in view.

2 - NAV PAGES

Satellite Status Page

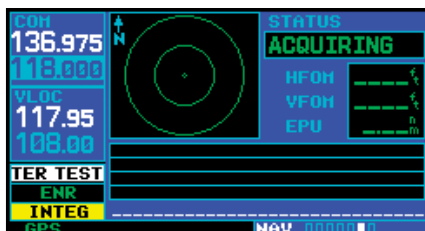

- 3D Navigation —
The GPS receiver is in 3D navigation mode and computes altitude using satellite data.
- 3D Differential Navigation— The GPS receiver is in 3D navigation mode and differential corrections are being used.

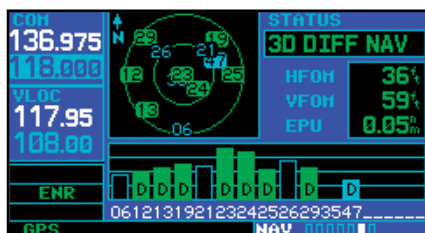

The Satellite Status Page also indicates the accuracy of the position fix, using Horizontal Figure of Merit (HFOM), Vertical Figure of Merit (VFOM), and Estimated Position Uncertainty (EPU). HFOM and VFOM represent the 95% confidence levels in horizontal and vertical accuracy. The lowest numbers are the best accuracy and the highest numbers are worse. EPU is the horizontal position error estimated by the Fault Detection and Exclusion (FDE) algorithm, in feet or meters.



NOTE Operating outside of an SBAS service area with SBAS enabled may cause elevated EPU values to be displayed on the satellite status page. Regardless of the EPU value displayed, the INTEG annunciation is the controlling indication for determining the integrity of the GPS navigation solution.

Vertical Navigation Page



WARNING: VNAV is to be used for advisory purposes only. VNAV messages or vertical speed required should not be used to maintain terrain or ATC clearances. Terrain and ATC clearances are the sole responsibility of the pilot.

The 400W-series vertical navigation page (the last NAV page) allows you to create a three-dimensional profile which guides you from your present position and altitude to a final (target) altitude at a specified location. This is helpful when you'd like to descend to a certain altitude near an airport. Once the profile is defined, message alerts and additional data on the default NAV and map pages will keep you informed of your progress.

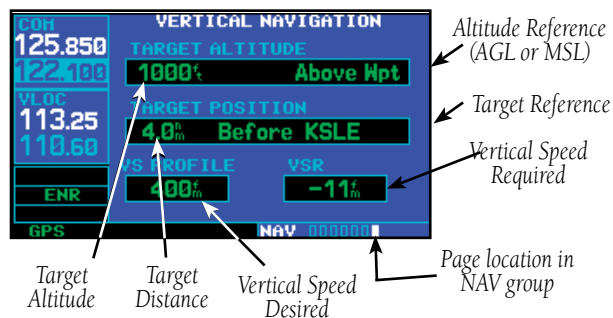

VNAV is inhibited in the following conditions:

- Groundspeed is less than 35 knots
- No active flight plan or direct-to destination
- SUSP mode
- Vectors-to-Final mode
- VLOC mode
- After the FAF on an approach

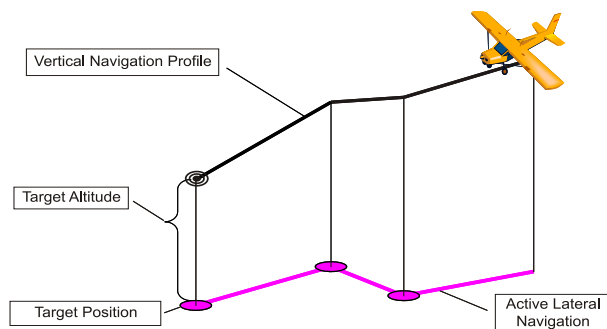

To create a vertical navigation profile:

1. Press the **small right** knob to activate the cursor.
2. Turn the **large right** knob to highlight the target altitude field.
3. Turn the **small** and **large right** knobs to select the target altitude and press **ENT**.

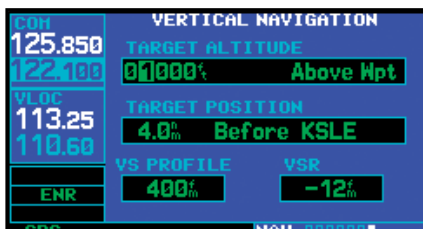

4. Turn the **small right** knob to select "Above Wpt" (AGL) or "MSL", and press **ENT**. "Above Wpt" will use the altitude of a destination airport as stored in the Jeppesen NavData card. "MSL" lets you set a specific target altitude for any waypoint category: airport, VOR, NDB, intersection or user waypoint.



5. Turn the **small** and **large right** knobs to select a distance from the target reference waypoint and press **ENT**. If the target altitude should occur at the target reference waypoint, enter a distance of zero.

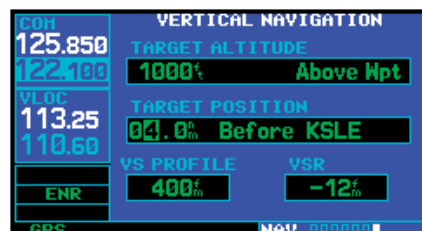

6. Turn the **small right** knob to select "Before" or "After", and press **ENT**. This setting designates whether the offset distance defines a point before you reach the target reference waypoint or after you reach the waypoint. "After" is not available for the last waypoint.
7. When using a flight plan, the target reference waypoint itself can be specified from the waypoints contained in the flight plan. By default, the last waypoint in the flight plan will be selected. To select a different waypoint, turn the **small right** knob to select the desired waypoint and press **ENT**.



8. The default profile utilizes a 400 foot-per-minute descent rate. To change the rate, turn the **large right** knob to highlight the "VS Profile" field and use the **small** and **large right** knobs to enter a new rate. Press **ENT** when finished.

2 - NAV PAGES

Vertical Navigation - VNAV

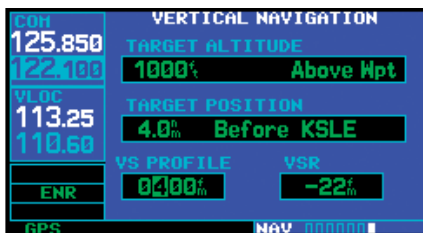

With the profile set, the vertical speed required (VSR) is displayed on the *vertical navigation page*. Expect the following to occur when using the vertical navigation feature:

- At one minute prior to reaching the initial descent point, a message “Approaching VNAV Profile” occurs. The descent angle will also lock to prevent changes in speed from altering the profile.
- If selected, the vertical speed required (VSR) readout on the default NAV and map pages will show the desired vertical speed to maintain the proper descent angle. Maximum VSR that can be displayed is -6000 ft/min. If VSR exceeds -6000 ft/min, dashes will be displayed.
- Course reversals are not included in the VNAV calculations until the aircraft begins the course reversal. While reversing course, VNAV includes direct-to the course reversal waypoint in the VNAV calculation.
- At 500 feet above the target altitude, an “Approaching Target Altitude” message is provided. The VSR readout on the default NAV and map pages is blanked out, at this point.

Vertical navigation messages can be turned on or off. (By default the messages are off.) Turning the messages off allows you to keep the profile settings you’ve entered previously, without having them generate messages when the feature isn’t needed.

To disable/enable the vertical navigation (VNAV) messages:

1. Press **MENU** to display the vertical navigation page options menu.



2. With “VNAV Messages On?” highlighted, press **ENT**. Or, if the messages are already on and you wish to turn them off, make sure “VNAV Messages Off?” is highlighted and press **ENT**.

To restore the factory default VNAV settings:

1. On the Nav VNAV page, press the **MENU** key.
2. Turn the **large right** knob to highlight “Restore Defaults” and then press **ENT**.



Dead Reckoning

Dead reckoning is the process of continuing navigation using your last known position and speed after a loss of GPS navigation while on an active flight plan.



CAUTION: *Navigation using dead reckoning is therefore only an estimate and should not be used as the sole means of navigation. Use other means of navigation, if possible.*

Dead reckoning becomes active after a loss of GPS position while you are navigating using an active flight plan. A pop-up message will appear and you must clear the message before continuing operation.

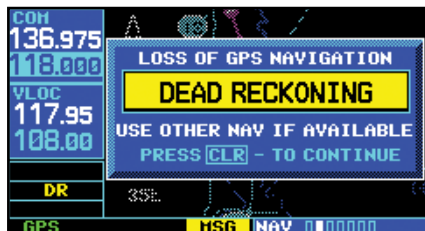

The ownship icon color is changed to yellow. The To/From flag is removed from the CDI. The Dead Reckoning annunciator (DR) appears on the left side of the map display when GPS position is unavailable and the unit is in Dead Reckoning mode. All external outputs dependent on GPS position are flagged.

Terrain will be noted as not available and new terrain advisory pop-ups will not occur. Traffic and Stormscope information will not be shown on the Map page, but will continue to be available on their own dedicated pages. XM and FIS-B weather will still be available on the Map page.

Dead Reckoning mode will continue until GPS position is restored, when GPS navigation is restored Dead Reckoning mode is exited. The DR annunciations will be removed and GPS information will be used to

compute navigation related information for the current flight phase.

Dead Reckoning is only allowed in En Route and Oceanic flight modes. If the unit is in a Terminal or Approach flight mode when Dead Reckoning takes place, “No GPS Position” will be displayed on the map pages and all navigation data will be dashed. If you are operating in Dead Reckoning mode and a transition to Terminal or Approach flight modes would occur from the projected Dead Reckoning position, Dead Reckoning mode will be discontinued. “No GPS Position” will be displayed on the map pages and all navigation data will be dashed.

Blank Page

Section 3

Direct-To Navigation

The direct-to function provides a quick method of setting a course to a waypoint. Once a direct-to is activated, the unit will establish a point-to-point course line (geodesic path) from your present position to the selected direct-to waypoint. The unit will provide navigation guidance to the selected direct-to waypoint until the direct-to is manually cancelled or replaced by a new active leg or direct-to.

To select a direct-to waypoint:

1. Press the **direct-to** key. The select direct-to waypoint page will appear, with the waypoint identifier field highlighted.

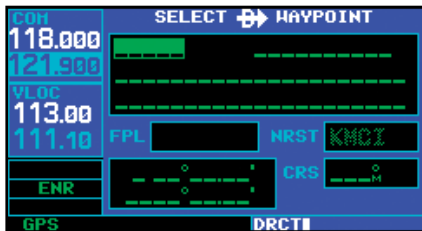

2. Use the **small** and **large right knobs** to enter the identifier of the desired direct-to waypoint.



3. Press **ENT** to confirm the selected waypoint, and **ENT** again to activate the direct-to function.

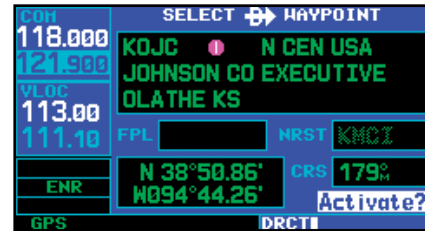

If you're navigating to a waypoint and get off course, the direct-to function may also be used to re-center the CDI (HSI) needle and proceed direct-to the active waypoint.

To re-center the CDI (HSI) needle to the active waypoint:

1. Press the **direct-to** key, followed by pressing **ENT** twice.



NOTE: If you're navigating an approach with the missed approach point (MAP) as the active waypoint, re-centering the CDI (HSI) needle with the direct-to key will cancel the approach.

3 - DIRECT-TO

Selecting a Waypoint

Selecting a Direct-To Waypoint by Facility Name or City

In addition to selecting a direct-to waypoint by identifier, the *select direct-to waypoint page* also allows you to select airports, VORs and NDBs by facility name or city location. If duplicate entries exist for the entered facility name or city, additional entries may be viewed by continuing to turn the **small right** knob during the selection process.

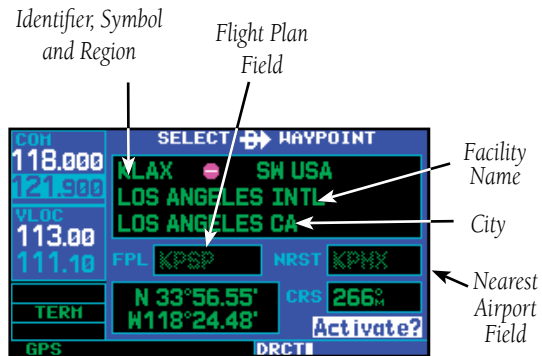

To select a direct-to waypoint by facility name or city:

1. Press the **direct-to** key. The select direct-to waypoint page will appear, with the waypoint identifier field highlighted.
2. Turn the **large right** knob to highlight the facility name (second line; see above) or the city (third line; see above) field.
3. Use the **small** and **large right** knobs to enter the facility name or city location of the desired direct-to waypoint. As you spell the facility name or city, the Spell'N'Find feature will select the first entry in the database based upon the characters you have entered up to that point.

4. Continue turning the **small right knob** to scroll through any additional database listings for the selected facility name or city. You can also scroll backwards with the **small right** knob if you scroll past the desired waypoint.
5. Press **ENT** to confirm the selected waypoint, and **ENT** to activate the direct-to function.



To select the direct-to waypoint by facility name (shown above) or city location (shown below), highlight the second or third line on the direct-to waypoint page. Use the small and large right knobs to enter the facility name or city. The identifier(s) for any matching entries will appear on the top line of the page.

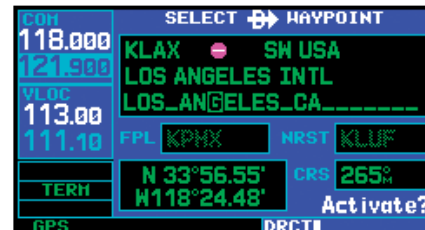

Selecting a Direct-To Waypoint from the Active Flight Plan

If you're navigating an active flight plan, any waypoint contained in the flight plan may be selected as a direct-to waypoint from the *select direct-to waypoint* page. (see *Section 4 - Flight Plans*, for more information on flight plans.)

To select a direct-to waypoint from the active flight plan:

1. Press the **direct-to** key. The select direct-to waypoint page will appear, with the waypoint identifier field highlighted.
2. Turn the **large right** knob to highlight the flight plan (FPL) field.



3. Turn the **small right** knob to display a window showing all waypoints in the active flight plan.



4. Continue turning the **small right** knob to scroll through the list and highlight the desired waypoint.
5. Press **ENT** to confirm the selected waypoint, and **ENT** to activate the direct-to function.

Selecting the Nearest Airport as a Direct-To Waypoint

The *select direct-to waypoint* page always displays the nearest airports (from your present position) on the NRST field. Navigating directly to a nearby airport is always just a few simple steps away. (Nearby airports may also be selected as direct-to waypoints using the steps described *Section 7 - NRST Pages - Navigating to a Nearby Waypoint*.)

To select a nearby airport as a direct-to waypoint:

1. Press the **direct-to** key. The select direct-to waypoint page will appear, with the waypoint identifier field highlighted.
2. Turn the **large right** knob to highlight the nearest airport (NRST) field.
3. Turn the **small right** knob to display a window showing up to nine nearby airports.



4. Continue turning the **small right** knob to scroll through the list and highlight the desired airport.
5. Press **ENT** to confirm the selected airport, and **ENT** to activate the direct-to function.



NOTE: Performing a direct-to the MAP of an active approach will cancel approach mode.

Shortcuts

Shortcuts are available when using the **direct-to** key, allowing you to bypass the use of the **small** and **large right** knobs to enter the waypoint's identifier. A direct-to can be performed from any page displaying a single waypoint identifier (such as the WPT pages for airports and nav aids) by simply pressing **direct-to** and **ENT**. For pages that display a list of waypoints (e.g., the *nearest airport* page), you must highlight the desired waypoint with the cursor before pressing the **direct-to** key.

To select an on-screen waypoint (other than the map page) as a direct-to waypoint:

1. If a single airport, nav aid or user waypoint is displayed on-screen: press **direct-to**, then press **ENT** twice.



2. If a list of waypoints is displayed on-screen: press the **small right** knob to activate the cursor, turn the **large right** knob to highlight the desired waypoint, then press **direct-to** followed by **ENT** twice.



Direct-to waypoints may also be selected from the *map page*, by panning to the desired location and pressing **direct-to** and **ENT** (twice). If no airport, nav aid or user waypoint exists at the desired location, a waypoint named "+MAP" will automatically be created at the location of the panning pointer.

To select a direct-to waypoint from the map page:

1. From the map page, press the **small right** knob to display a panning pointer.
2. Turn the **small** and **large right** knobs to place the panning pointer at the desired location.



3. If the panning pointer is placed on an existing airport, nav aid or user waypoint, the waypoint name will be highlighted. Press **direct-to** and then **ENT** twice to navigate to the waypoint.
4. If the panning pointer is placed on an open location, press **direct-to** and **ENT** twice to create a "+MAP" waypoint and navigate to it.

Cancelling Direct-To Navigation

Once a direct-to is activated, the unit will provide navigation guidance to the selected waypoint until the direct-to is manually cancelled or replaced by a new active leg or direct-to.

To cancel a direct-to:

1. Press the **direct-to** key to display the select direct-to waypoint page.
2. Press **MENU** to display the direct-to options menu.



3. With "Cancel Direct-To NAV?" highlighted, press **ENT**. If a flight plan is still active, the unit will resume navigating the flight plan along the closest leg.

Specifying a Course to a Waypoint

Whenever you perform a direct-to, the unit will set a direct geodesic course to the selected waypoint. You can also manually define the course to the selected waypoint, using the "CRS" course field on the *select direct-to waypoint page*.

To manually define the direct-to course:

1. Press the **direct-to** key.
2. Use the **small** and **large right** knobs to select the desired waypoint.
3. Press **ENT** to confirm the selected waypoint, then turn the **large right** knob to highlight the course ("CRS") field.

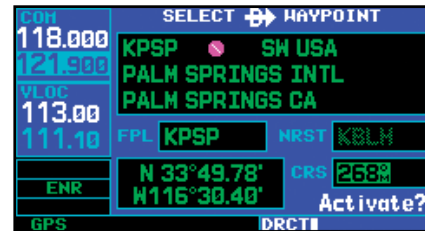

4. Turn the **small** and **large right** knobs to select the desired course and press **ENT**.

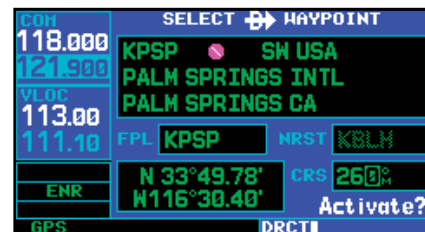

5. Press **ENT** again to begin navigation using the selected waypoint and course.

Selecting Direct-To a Holding Pattern

You may select a Direct-To course to a holding pattern that is in your flight plan.

To set a direct-to course to a holding pattern:

1. Press the **FPL** key to reach the active flight plan page.
2. Press the **small right** knob to activate the cursor. Turn the **large right** knob to highlight the hold leg of the flight plan.



3. Press **direct-to**. "Activate" will be highlighted. Press **ENT** to activate a course Direct-To the holding pattern. Or, press **CLR** to cancel the process.



4. The holding pattern waypoint will now be set as the direct-to waypoint.



Section 4 Flight Plans

The 400W-series lets you create up to 20 different flight plans, with up to 100 waypoints in each flight plan. The flight plan page group consists of two pages, accessed by pressing the **FPL** key. The Active Flight Plan page shows the legs and details in the active flight plan. The Flight Plan Catalog contains flight plans that you have created and saved for future use. The flight plan pages allow you to create, edit and copy flight plans. There are separate options available in both the Active Flight Plan page and the Flight Catalog page.

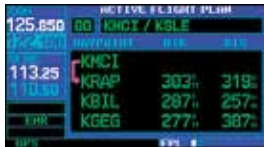

Active Flight Plan Page

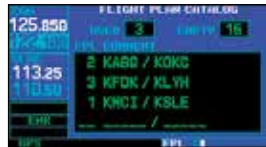

Flight Plan Catalog Page

Flight Plan Catalog

The Flight Plan Catalog allows you to create, edit, activate, delete and copy flight plans. Flight plans numbered from 1 through 19 are used to save flight plans for future use. “Flight plan 00” is reserved exclusively for the flight plan currently in use for navigation. Any time you activate a flight plan, a copy of the flight plan is automatically transferred to “flight plan 00” and overwrites any previously active flight plan.

Flight Plan Catalog Editing

To add a waypoint to an existing flight plan:

1. Press **FPL** and turn the **small right** knob to display the flight plan catalog.
2. Press the **small right** knob to activate the cursor.
3. Turn the **large right** knob to highlight the desired flight plan and press **ENT**.

4. Turn the **large right** knob to select the point where you wish to add the new waypoint. If an existing waypoint is highlighted, the new waypoint will be placed directly in front of this waypoint.



5. Use the **small** and **large right** knobs to enter the identifier of the new waypoint and press **ENT**.



6. Once all changes have been made, press the **small right** knob to return to the flight plan catalog.

To delete a waypoint from an existing flight plan:

1. Press **FPL** and turn the **small right** knob to display the flight plan catalog.
2. Press the **small right** knob to activate the cursor.
3. Turn the **large right** knob to highlight the desired flight plan and press **ENT**.
4. Turn the **large right** knob to select the waypoint you wish to delete and press **CLR** to display a “remove waypoint” confirmation window.

4 - FLIGHT PLANS

Flight Plan Catalog

- With "Yes" highlighted, press **ENT** to remove the waypoint.
- Once all changes have been made, press the **small right** knob to return to the flight plan catalog.

A one-line user comment may be added to any flight plan, which will be displayed on the flight plan catalog, next to the flight plan's number. By default, as the flight plan is being created, the comment will show the first and last waypoints in the flight plan.

To change the comment line for an existing flight plan:

- From the flight plan catalog, press the **small right** knob to activate the cursor.
- Turn the **large right** knob to highlight the desired flight plan and press **ENT**.
- Turn the **large right** knob to select the comment line at the top of the screen.
- Use the **small** and **large right** knobs to enter the new comment. Press **ENT** when finished.



- Once all changes have been made, press the **small right** knob to return to the flight plan catalog.

Flight Plan Catalog Options

The following options are available for the Flight Plan Catalog:

- Activate Flight Plan
- Invert and Activate Flight Plan
- Create New Flight Plan
- Crossfill
- Copy Flight Plan
- Delete Flight Plan
- Delete All Flight Plans
- Sort List by Number/Comment

Activating Flight Plans

Activate Flight Plan? allows you to select the flight plan for navigation guidance. Once a flight plan is defined through the Flight Plan Catalog, it may be activated for navigation. Activating the flight plan places it into "flight plan 00" and overwrites any previous information at that location.

To activate an existing flight plan:

- From the flight plan catalog, press the **small right** knob to activate the cursor.
- Turn the **large right** knob to highlight the desired flight plan and press **MENU** to display the flight plan catalog options.
- Turn the **large right** knob to highlight "Activate Flight Plan?" and press **ENT**.



Inverting Flight Plans

Invert FPL? allows you to reverse the highlighted flight plan and select it for navigation guidance. After travelling along a flight plan, you may wish to reverse the route for navigation guidance back to your original departure point.

To activate an existing flight plan in reverse order:

1. From the flight plan catalog, press the **small right** knob to activate the cursor.
2. Turn the **large right** knob to highlight the desired flight plan and press **MENU** to display the flight plan catalog options.
3. Turn the **large right** knob to highlight "Invert FPL?" and press **ENT**. The original flight plan will remain intact in its flight plan catalog storage location.



Create a new flight plan

Create New Flight Plan? allows you to create a new flight plan. The new flight plan will be saved in the Flight Plan Catalog.

To create a new flight plan:

1. Press **FPL** and turn the **small right** knob to display the flight plan catalog.
2. Press **MENU** to display the flight plan catalog options.

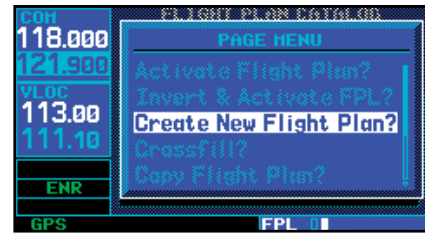

3. Turn the **large right** knob to highlight "Create New Flight Plan?" and press **ENT**.
4. A blank flight plan page will appear for the first empty storage location. Use the **small** and **large right** knobs to enter the identifier of the departure waypoint and press **ENT**.



5. Repeat step #4 above to enter the identifier for each additional flight plan waypoint.
6. Once all waypoints have been entered, press the **small right** knob to return to the flight plan catalog.

4 - FLIGHT PLANS

Flight Plan Catalog Options

Crossfill

Crossfill? allows you to transfer a direct-to destination, the active flight plan including VNAV parameters, any stored flight plan or user waypoints to a second 400W-Series or 500W-Series Garmin unit.

See Section 9 - Aux Pages - Flight Planning - Crossfill Operation for additional details on using the “Crossfill?” option.

Copying Flight Plans

Copy Flight Plan? allows you to copy the selected flight plan to a new flight plan location. The copy function is useful for duplicating an existing flight plan before making changes. If you want to save a flight plan currently located in “flight plan 0”, be sure to copy it to an open catalog location (1-19) before the flight plan is cancelled, overwritten or erased.

To copy a flight plan to another flight plan catalog location:

- 1a. From the active flight plan page, press **MENU** to display the active flight plan options window.

or

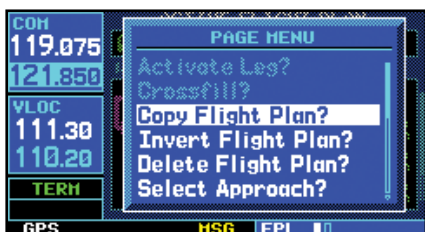

- 1b. From the flight plan catalog, press the **small right** knob to activate the cursor, turn the **large right** knob to highlight the flight plan you wish to copy, then press **MENU** to display the flight plan catalog options.

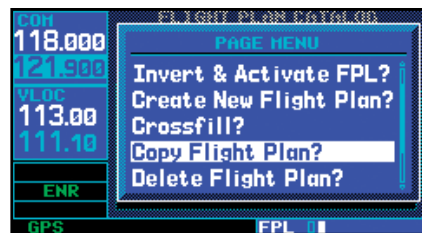

2. Turn the **large right** knob to highlight “Copy Flight Plan?” and press **ENT**.
3. By default, the next empty catalog location will be offered. To select a different location, turn the **large right** knob to select the flight plan number, use the **small** and **large right** knobs to enter a different number and press **ENT**.
4. With “Yes?” highlighted, press **ENT** to copy the flight plan.

Deleting Flight Plans

Delete Flight Plan? allows you to remove the selected flight plan from memory. Deleting a flight plan does not delete the individual waypoints contained in the flight plan from the database or user waypoint memory. Once you are finished with a flight plan, it can easily be deleted from the flight plan catalog or the active flight plan page.

To delete a flight plan:

- 1a. From the active flight plan page, press **MENU** to display the active flight plan options window.
- or
- 1b. From the flight plan catalog, press the **small right** knob to activate the cursor, turn the **large right** knob to highlight the flight plan you wish to copy, then press **MENU** to display the flight plan catalog options.

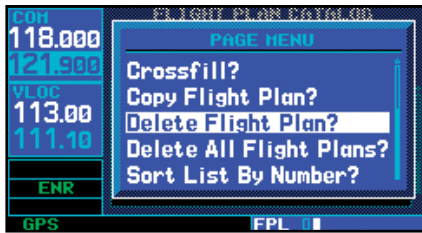

2. Turn the **large right** knob to highlight “Delete Flight Plan?” and press **ENT**.
3. With “Yes?” highlighted, press **ENT** to delete the flight plan.

Deleting All Flight Plans

Delete All Flight Plans? allows you to remove all flight plans from memory.

To delete all flight plans:

1. Select the “Delete All Flight Plans?” option from the flight plan catalog options and press **ENT**.



2. A confirmation window will appear. With “Yes?” highlighted, press **ENT**.



Sort List By Number?/Sort List by Comment?

Sort List By Number?/Sort List by Comment?

The sorting function allows you to select between a flight plan catalog sorted numerically by the flight plan number or sorted alphanumerically based upon the comment assigned to each flight plan. When either option is selected, the other option will appear on the flight plan catalog options window.

To sort the catalog listing by number or comment:

1. Select the “Sort List By Number?” or “Sort List By Comment?” option (whichever is currently displayed) from the flight plan catalog options and press **ENT**.



4 - FLIGHT PLANS

Flight Plan Catalog Options

Active Flight Plan Page

The active flight plan page provides information and editing functions for “flight plan 00”— the flight plan currently in use for navigation. Once you have activated a flight plan, the active flight plan page will show each waypoint for the flight plan, along with the desired track (DTK) and distance (DIS) for each leg. The data fields for DTK and DIS are user-selectable and may be changed to display cumulative distance (CUM) to each waypoint, estimated time of arrival (ETA), estimated time en route (ETE) or en route safe altitude (ESA).

To change a data field on the active flight plan page:

1. With the active flight plan page displayed, press **MENU** to display the active flight plan page options window.
2. Turn the **large right** knob to highlight “Change Fields?” and press **ENT**.

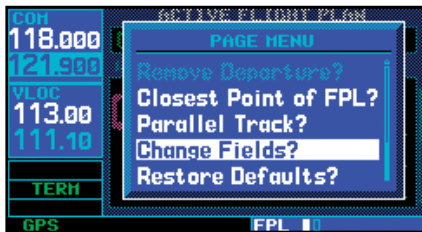

3. Turn the **large right** knob to highlight the field you wish to change.
4. Turn the **small right** knob to select the desired data item and press **ENT**.



5. Press the **small right** knob to remove the cursor.

To restore factory default settings for data fields on the active flight plan page:

1. With the active flight plan page displayed, press **MENU** to display the active flight plan page options window.
2. Turn the **large right** knob to highlight “Restore Defaults?” and press **ENT**.

Active Flight Plan Options

The following options (some covered on the preceding pages) are available for the *active flight plan*:

- Activate Leg
- Crossfill or Manual GTN Crossfill
- Copy Flight Plan
- Invert Flight Plan
- Delete Flight Plan
- Select Approach
- Select Arrival
- Select Departure
- Remove Approach
- Remove Arrival
- Remove Departure
- Closest Point of Flight Plan
- Parallel Track
- Change Fields
- Restore Defaults

Activate Leg

Activate Leg? activates/reactivates the flight plan and selects the highlighted leg as the “active leg” (the leg which will currently be used for navigation guidance).

To activate a flight plan along a specific leg:

1. Press the **small right** knob to activate the cursor and turn the large right knob to highlight

the desired destination waypoint.

2. Select the “Activate Leg?” option from the active flight plan page options and press **ENT**.

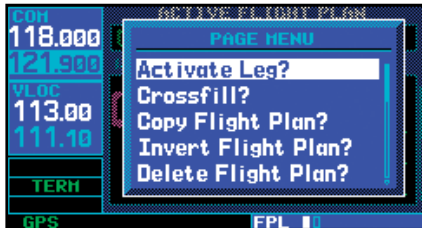

3. A confirmation window will appear. With “Activate?” highlighted, press **ENT**.

Crossfill

Crossfill? allows you to transfer the active flight plan, including VNAV parameters, between two 400W- or 500W-series Garmin units in a dual unit installation. See the description on a previous page in the Flight Plan section. See Section 9 - Aux Pages - Flight Planning - Crossfill Operation for additional details on using the “Crossfill?” option.

Manual GTN Crossfill

Manual GTN Crossfill? allows you to transfer user waypoints to a GTN unit or receive information from a GTN unit.

See Section 9 - Aux Pages - Flight Planning - Manual GTN Crossfill Operation for additional details on using the “Manual GTN Crossfill?” option.

Copy Flight Plan

Copy Flight Plan? copies the active flight plan to a flight plan catalog location. The copy function is useful for duplicating the active flight plan before making changes. This feature is described earlier in this section.

Invert Flight Plan

Invert Flight Plan? reverses the active flight plan. This feature is described earlier in this section.

1. With the Active Flight Plan Page displayed, press **MENU** to display the Active Flight Plan Page Options window.
2. Turn the **large right** knob to highlight “Invert Flight Plan?” and press **ENT**.

Delete Flight Plan

Delete Flight Plan? allows you to remove all waypoints from the selected flight plan. Deleting a flight plan does not delete the waypoints contained in the flight plan from the database or user waypoint memory. This feature is described earlier in this section.

1. With the Active Flight Plan Page displayed, press **MENU** to display the Active Flight Plan Page Options window.
2. Turn the **large right** knob to highlight “Delete Flight Plan?” and press **ENT**.
3. A window will appear with the message “Delete all flight plans?”. Turn the **large right** knob to highlight “Yes” or “No”. Press **ENT**.



4 - FLIGHT PLANS

Active Flight Plan Options

Select Approach

Select Approach? allows you to select a published instrument approach for the destination airport, or replace the current approach with a new selection. In many cases, you'll find it more convenient to select approaches using the **PROC** key— as described in Section 5 - Procedures.

To select an approach for a direct-to or flight plan destination airport:

1. Press **MENU** and choose the "Select Approach?" option from the active flight plan page options with the **large right** knob and press **ENT**.



2. A window will appear listing the available approaches for your destination airport. Turn the **small right** knob to highlight the desired approach and press **ENT**.



3. A second window will appear listing available transitions for the approach. Turn the **small right** knob to highlight the desired transition waypoint and press **ENT**. (The "Vectors" option assumes you will receive vectors to the final course segment of the approach and will provide navigation guidance to intercept this final course.)



4. Turn the **large right** knob to highlight "Load?" or "Activate?" and press **ENT**. "Load?" will add the approach to the flight plan without immediately using the approach for navigation guidance. This allows you to continue navigating the original flight plan until cleared for the approach—but, keeps the approach available for quick activation when needed.
5. For approaches not approved for GPS, a reminder window will appear indicating that GPS guidance on such approaches is strictly for monitoring only. To confirm this reminder, highlight "Yes?" and press **ENT**.

Select Arrival

Select Arrival? allows you to select a published standard terminal arrival route (STAR) for the destination airport, or replace the current arrival with a new selection.

To select an arrival for a direct-to or flight plan destination airport:

1. Select the "Select Arrival?" option from the active flight plan page options and press **ENT**.



2. A window will appear listing the available transitions for your destination airport. Turn the **small right** knob to highlight the desired transition waypoint and press **ENT**.

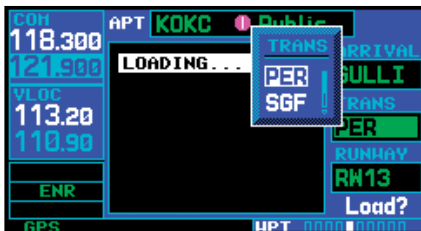

3. A second window will appear listing available runways for the transition. Turn the **small right** knob to highlight the desired runway and press **ENT**.



4. With "Load?" highlighted, press **ENT**.

Select Departure

Select Departure? allows you to select a published standard instrument departure (SID) for the departure airport, or replace the current departure with a new selection. When using a direct-to, the 400W-series will use the nearest airport as a reference when displaying available departures. See Sec 5 - Procedures for information on selecting departures using the **PROC** key.

To select a departure for the departure airport:

1. Select the "Select Departure?" option from the active flight plan page options and press **ENT**.
2. A window will appear listing the available departures for your departure airport. Turn the **small right** knob to select the desired departure and press **ENT**.
3. A second window will appear listing available transitions for the departure. Turn the **small right** knob to highlight the desired transition waypoint and press **ENT**.
4. With "Load?" highlighted, press **ENT**.

4 - FLIGHT PLANS

Active Flight Plan Options

Remove Approach, Arrival, or Departure

Remove Approach? deletes the currently selected approach from the active flight plan. **Remove Arrival?** deletes the current Arrival (STAR) from the active flight plan. **Remove Departure?** deletes the current departure (SID) from the active flight plan.

To remove an approach, arrival or departure from the active flight plan:

1. Press **MENU** and turn the **large right** knob to select the "Remove Approach?", "Remove Arrival?" or "Remove Departure?" option from the active flight plan page options and press **ENT**.



2. A confirmation window will appear listing the procedure you are about to remove. With "Yes?" highlighted, press **ENT**.

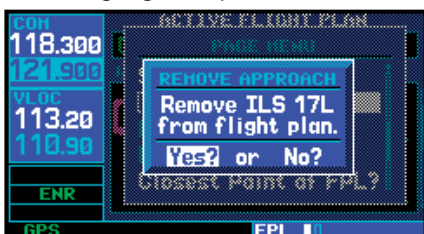

Closest Point of FPL

Closest Point of FPL? calculates the bearing and closest distance that a flight plan will pass from a reference waypoint. May also be used to create a new user waypoint along the flight plan at the location closest to the reference waypoint.

To determine the closest point, along the active flight plan, to a selected waypoint:

1. Select the "Closest Point of FPL?" option from the active flight plan page options and press **ENT**.

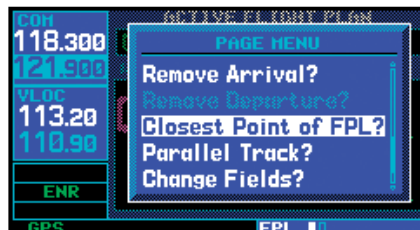

2. A window will appear with the reference waypoint field highlighted. Use the **small** and **large right** knobs to enter the identifier of the reference waypoint and press **ENT**.
3. A confirmation window will appear for the selected reference waypoint. Press **ENT** to accept the waypoint.
4. The 400W-series will display the bearing (BRG) and distance (DIST) to the closest point along the flight plan, from the selected reference waypoint. To create a user waypoint at this location and add it to the flight plan, highlight "Load?" and press **ENT**. The name for the new user waypoint will be derived from the identifier of the reference waypoint.



Parallel Track

Parallel Track? allows you to create a parallel course offset of 1 to 99 NM to the left or right of your current flight plan. After setting a parallel track to your current flight plan, a magenta parallel track line will be drawn offset from the original by the selected distance. The original course line will be drawn in white. The aircraft will navigate to the parallel track course line.

When you reach the end of the flight plan, an annunciator message will state “PTK END X S”. The message will give the pilot sufficient time to intercept the original course.

Points to remember with Parallel Track:

- You must have an active flight plan
- The current leg must support parallel track
- Parallel track is not allowed for the active leg of an approach
- Parallel track is not allowed if the active leg is not a track-to-fix or direct-to-fix leg
- Parallel track may be allowed but not the selected offset distance

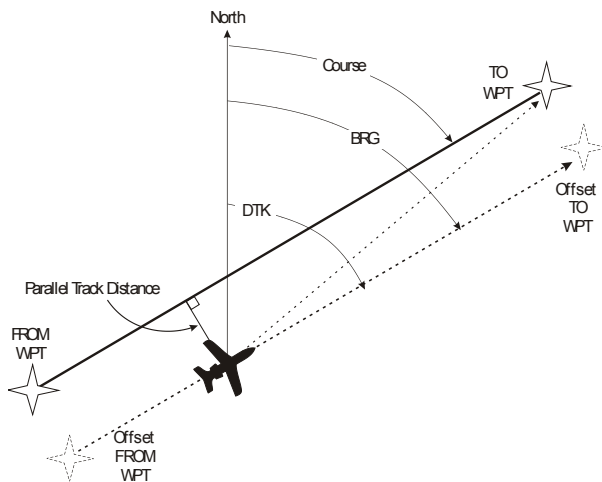

To set a parallel track to your flight plan.

1. With the Active Flight Plan Page displayed, press **MENU** to display the Active Flight Plan Page Options window.

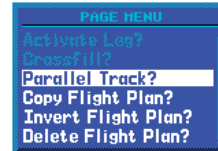

Select “Parallel Track?” to set a parallel track to your current flight plan.

2. Turn the **large right** knob to highlight “Parallel Track?” and press **ENT**.
3. Turn the **small** and **large right** knobs to set the Offset Distance value and then press **ENT**.

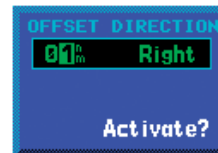

Turn the small and large knobs to select the parallel track distance from your current flight plan.

4. Turn the **large right** knob to highlight the Offset Direction.
5. Turn the **small right** knob to select the desired Offset Direction and press **ENT**.



Turn the small and large knobs to select the parallel track direction from your current flight plan.

6. **Activate?** is highlighted. Press **ENT** to activate the selected Parallel Track. Or, press **CLR** or the **CRSR** to cancel Parallel Track selection.

4 - FLIGHT PLANS

Active Flight Plan Shortcuts

To cancel a parallel track to your flight plan.

1. With the Active Flight Plan Page displayed, press **MENU** to display the Active Flight Plan Page Options window.
2. Turn the **large right** knob to highlight "Parallel Track?" and press **ENT**.
3. "Cancel?" is highlighted. Press **ENT**.

Change Fields

Change Fields? allows you to select the desired data items to display on the active flight plan page.

1. With the Active Flight Plan Page displayed, press **MENU** to display the Active Flight Plan Page Options window.
2. Turn the **large right** knob to highlight "Change Fields?" and press **ENT**. The field active for selection will flash. Turn the **large right** knob to highlight the field to change.



3. Turn the **small right** knob to open the list of selections and continue turning it to highlight the desired selection and then press **ENT**.

Restore Defaults

Restore Defaults? returns the data items to factory defaults.

1. With the Active Flight Plan Page displayed, press **MENU** to display the Active Flight Plan Page Options window.
2. Turn the **small right** knob to highlight "Restore Defaults?" and then press **ENT**.

Shortcuts

A number of shortcuts are available to save time when using the active flight plan page. These shortcuts speed the process of removing approaches, departures, and arrivals, and aid in selecting a specific flight plan leg for navigation guidance.

On the preceding page, options to remove approaches, departures and arrivals were introduced. This process may also be completed using the **CLR** key, as described below and illustrated at left.

To remove an approach, departure, or arrival using the CLR key:

1. With the active flight plan page displayed, press the **small right** knob to activate the cursor.
2. Turn the **large right** knob to highlight the title for the approach, departure or arrival you wish to delete. Titles will appear in light blue directly above the procedure's waypoints.



3. Press **CLR** to display a confirmation window.



4. With "Yes?" highlighted, press **ENT** to remove the selected procedure.

This same process may also be used to remove individual waypoints from the active flight plan.

To remove a waypoint using the CLR key:

1. With the active flight plan page displayed, press the **small right** knob to activate the cursor.
2. Turn the **large right** knob to highlight the identifier for the waypoint you wish to delete. Identifiers will appear in green text.
3. Press **CLR** to display a confirmation window.



4. With "Yes?" highlighted, press **ENT** to remove the selected procedure.

The "Activate Leg?" provides a shortcut that allows you to specify which leg of the flight plan will currently be used for navigation guidance, using the **direct-to** key.

To activate a specific leg of the active flight plan:

1. Press the **small right** knob to activate the cursor and turn the **large right** knob to highlight the desired destination waypoint.



2. Press **direct-to** twice to display an "Activate Leg" confirmation window.



3. With "Activate?" highlighted, press **ENT**.

When using instrument procedures, this feature can be used not only to activate a specific point-to-point leg, but to also activate the procedure turn portion of an approach, follow a DME arc or activate a holding pattern.

Any approach, departure or arrival can be reviewed on the appropriate airport page in the Waypoint page group.

To review a procedure while viewing a flight plan page:

1. With a flight plan page displayed, press the **small right** knob to activate the cursor.
2. Turn the **large right** knob to highlight the procedure header and press **ENT** to select the WPT page group.



4 - FLIGHT PLANS

Active Flight Plan Shortcuts

Flight Plan Transfer Feature (optional with software V 3.20 or later)

The Flight Plan Card feature is available for transferring flight plans to the unit via a Garmin proprietary data card. The flight plans may be created on a PC using flight planning software that is compatible with Garmin equipment (Jeppesen FliteStar is an example). In addition to the flight planning software, it is necessary to purchase a flight plan transfer kit from Garmin. The kit contains the required hardware (including a blank data card and card programmer) and Garmin software that must be installed on the PC. Up to 19 flight plans and 1,000 user waypoints, created using the flight planning software, can be loaded on to a data card via the PC software and then transferred to the 500W Unit using the procedure described below. The process can be repeated as many times as desired using the same card with different flight plans and user waypoints loaded. If additional data cards are desired, they can be purchased from Garmin separately.



NOTE: *Flight plans are not verified by Garmin, it is the pilot's responsibility to verify all flight plans.*

Using the Flight Plan Card to load flight plans into the 400W Unit:

1. With the unit powered off, remove the Terrain Card, located in the right slot.
2. Place the Flight Plan Card in the empty right slot.
3. Apply power to the unit.
4. Once initialization has completed, the unit will default to the third FPL page (this third page only exists when the Flight Plan Card is in use).



5. Turn the **small right** knob to select the flight plan file to transfer and catalog number to use. Turn the **large right** knob to move between fields. Press **ENT** to confirm selections and initiate transfers.



NOTE: *If a user waypoint with the same name already exists in the 500W and is more than 10 meters from the imported user waypoint, the imported user waypoint will be automatically renamed by adding a digit (0-9) to the end of the waypoint's name. Also, a message will appear to inform the user that a waypoint has been renamed.*



NOTE: *Flight plan files that contain only user waypoints (with no flight plan route) may be transferred. In this case, only the user waypoints will be transferred and no flight plans will be modified. A message will appear to indicate this.*

6. Once all flight plans have been loaded, power off the unit.
7. Remove the Flight Plan Card from the right card slot and place the Terrain Card back into the empty card slot.



NOTE: *The Flight Plan Card is only to be used on the ground. It must be removed prior to flight.*

8. Apply power to the unit.
9. To activate a newly transferred flight plan, refer to Section Four "Activating Flight Plans."

Blank Page

Section 5 - Procedures - Approaches, Departures, & Arrivals

The 400W-series unit allows you to fly non-precision and precision approaches to airports with published instrument approach procedures. All available approaches are stored on your Jeppesen NavData® card, and are automatically updated when you replace the card with a new one. Subscription information for NavData cards is included in your 400W-series package.

The Procedures Page is displayed by pressing the **PROC** key. The Procedures Page provides direct access to approaches, departures and arrivals — based upon the active flight plan or direct-to destination. In either case, the departure and destination airports must have published procedures associated with them.

To select an approach, departure or arrival:

1. Press the **PROC** key to display the procedures page.

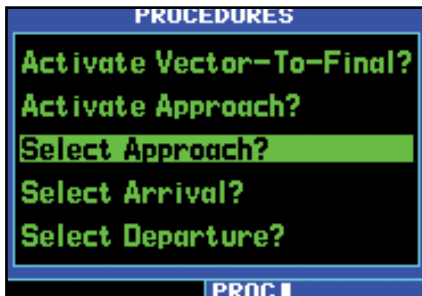

2. Turn the **large right** knob to highlight "Select Approach?", "Select Departure?" or "Select Arrival?" and press **ENT**.
3. A window will appear listing the available procedures. Turn the **large right** knob to highlight the desired procedure and press **ENT**. (When a direct-to destination is selected, departures are offered for the nearest airport.)



4. A second window will appear listing the available transitions. Turn the **large right** knob to highlight the desired transition waypoint and press **ENT**. (The approach "Vectors" option assumes you will receive vectors to the final course segment of the approach and will provide navigation guidance relative to the final approach course.)



5. Turn the **large right** knob to highlight "Load?" or "Activate?" (approaches only) and press **ENT**. "Load?" will add the procedure to the flight plan without immediately using it for navigation guidance. This allows you to continue navigating the original flight plan, but keeps the procedure available on the active flight plan page for quick activation when needed to later activate a departure or arrival.
6. For precision approaches and some non-precision approaches, a reminder window will appear indicating that GPS guidance on such approaches is strictly for monitoring only — use the VLOC receivers and external CDI (or HSI) for primary navigation. To confirm this reminder, highlight "Yes?" and press **ENT**.

5 - PROCEDURES

Activating Approaches



Not all approaches in the database are approved for GPS use. As you select an approach, a “G_P” designation to the right of the procedure name indicates the procedure can be flown using the GPS receiver. Some procedures will not have this designation, meaning the GPS receiver may be used for supplemental navigation guidance only. ILS approaches, for example, must be flown by tuning the VLOC receiver to the proper frequency and coupling the VLOC receiver to the external CDI (or HSI).

Once an approach is selected, it may be activated for navigation from the *procedures page*. Activating the approach overrides the “en route” portion of the active flight plan, proceeding directly to the “approach” portion (for a full approach, directly to the initial approach fix).

To activate an approach:

1. Press the **PROC** key to display the procedures page.
2. Turn the **large right** knob to highlight “Activate Approach?” and press **ENT**.

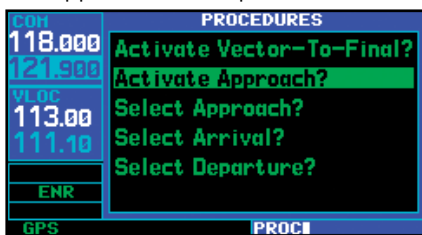

Another procedures page option allows you to activate the final course segment of the approach. This option assumes you will receive vectors to the final approach course and guides you to intercept the final course, before reaching the FAF.

To activate the approach, with vectors to final:

1. Press the **PROC** key to display the procedures page.
2. Turn the **large right** knob to highlight “Activate Vector-To-Final?” and press **ENT**.

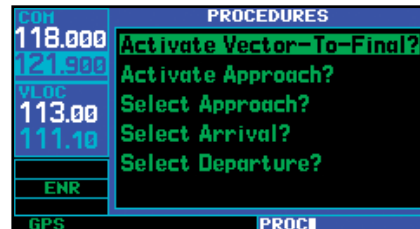

In many cases, it may be easiest to “Load” the full approach while still some distance away, en route to the destination airport. Later, if vectored to final, use the steps above to select “Activate Vectors-To-Final”—which makes the inbound course to the FAF waypoint active. Otherwise, activate the full approach using the “Activate Approach?” option.

If you reactivate the approach currently being flown using the **PROC** key, prior to reaching the MAP a Restart Approach confirmation window appears on the screen. If you have passed the MAP, the 400W-series unit proceeds to the transition waypoint without a restart confirmation.

Basic Approach Operations

The 400W series provides precision vertical guidance and non-precision advisory guidance using its built in GPS receiver. The moving map pages can also be used as a supplemental aid to situational awareness for ILS, VOR, and NDB approaches (and non-precision localizer-based approaches), but the appropriate navigational aid **MUST** be used for primary approach course guidance.

Approaches designed specifically for GPS are often very simple and don't require overflying a VOR or NDB. Currently, many non-precision approaches have "GPS overlays" to let you fly an existing procedure (VOR, VOR/DME, NDB, RNAV, etc.) more accurately using GPS. To date, there are over 2,400 GPS-only approaches and over 2,900 GPS overlay approaches worldwide.

Many overlay approaches are more complex (in comparison to GPS-only approaches). The 400W-series unit displays and guides you through each leg of the approach — automatically sequencing through each of these legs, up to the missed approach point (MAP). Approaches may be flown "as published" with the full transition — using any published feeder route or initial approach fix (IAF) — or may be flown with a vectors-to-final transition.

Flight mode annunciations are provided in the lower left corner of the display indicating the current mode of flight.

| Annunciation | Description |
|---------------------------|--|
| LPV | Localizer Performance with Vertical guidance (LPV) approach. Fly to LPV minimums. A yellow background indicates that the approach is safe to continue but a downgrade to LNAV may occur. |
| LP | Localizer Performance with no vertical guidance. Fly to LP minimums. SW V 3.30, or later. |
| LP +V | LP +V indicates Localizer Performance with advisory vertical guidance. Fly LP minimums down to the MDA and missed approach location. This annunciation is available in SW Ver 5.10, or later. |
| L/VNAV | Lateral Navigation and Vertical Navigation (LNAV/VNAV) approach. Fly to LNAV/VNAV minimums. |
| LNAV+V | GPS approach using published LNAV minima. Advisory vertical guidance is provided. |
| LNAV | Lateral Navigation approach. Fly to LNAV minimums. |
| MAPR | Missed Approach indicates the system is providing missed approach integrity and CDI full-scale deflection ± 0.3 NM. |
| ENR | En route, CDI full-scale deflection is 2.0 NM or current CDI scale selection, whichever is smaller. |
| TERM | Terminal, CDI full-scale deflection is 1.0 NM or current CDI scale selection, whichever is smaller. |
| DPRT | Departure, indicates the system is using non-precision approach integrity. HAL = 0.3 and CDI full-scale deflection is 0.3 NM. |
| OCN | Oceanic, CDI full-scale deflection is 2.0 NM. |
| LOW ALT (lower window) | For LNAV+V, LNAV/VNAV, or LPV approaches, the LOW ALT annunciation indicates the aircraft's estimated height is lower than the Final Approach Waypoint height by more than the current VPL plus 50 meters. This annunciation will not be active when Terrain is operational. |

5 - PROCEDURES

Procedure Turn Approach

Approach operations on the 400W-series will typically begin with the same basic steps:

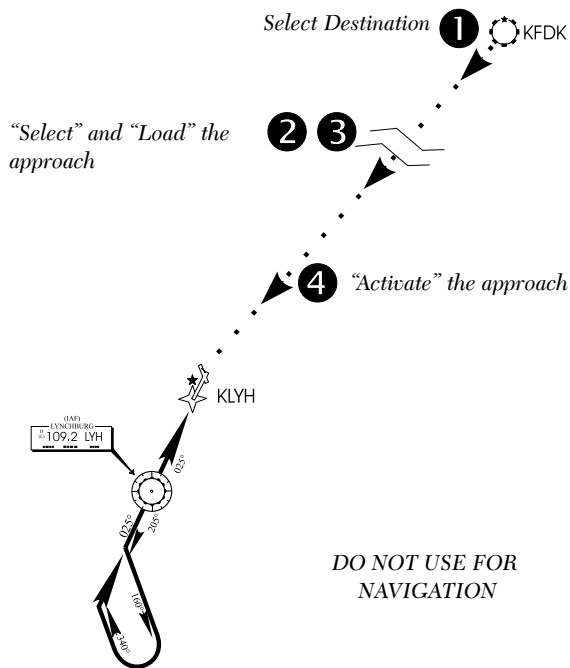

1. Select the destination airport using the **direct-to** key, or as the last waypoint in the active flight plan.
2. Choose the “Select Approach?” option from the procedures page or from the active flight plan options.
3. “Load” the approach (often while en route) in anticipation of its future use. This places the approach in the active flight plan, but retains course guidance in the en route section until the approach is “activated”.
4. “Activate” the full approach or vectors-to-final, as appropriate. In some scenarios, you may find it more convenient to immediately activate the approach and skip the “Load” process outlined above in step #3. The 400W-series provides both options.

Approaches with Procedure Turns

The procedure turn portion of an approach is stored as one of the legs of the approach. For this reason, the 400W-series requires no special operations from the pilot — other than flying the procedure turn itself — beyond what is required for any other type of approach.

This example uses the VOR Runway 04 GPS approach for Lynchburg (Virginia) Regional Airport, KLYH, and assumes a departure from Frederick (Maryland) Municipal Airport, KFDK. The steps required to set up and fly the approach are detailed below:

1. Prior to departing KFDK, the destination (KLYH) is selected using the **direct-to** key or by creating a flight plan terminating at Lynchburg Regional.
2. While en route to KLYH, some 40-50 NM away, you select the ATIS frequency to monitor airport conditions and runway usage. This is accomplished by selecting the NAVCOM page and selecting the ATIS frequency from the list. This places the frequency on standby. Use the **COM flip-flop** key to make the ATIS frequency active.

| ARRIVAL | KLYH | Public |
|---------|----------------|---------|
| 118.000 | ATIS | 119.300 |
| 124.900 | Approach Info? | 125.475 |
| 113.00 | Approach Info? | 135.000 |
| 111.10 | Tower | 127.650 |
| TERM | Unicom | 122.950 |
| GPS | NAV | 880 000 |

3. From ATIS you learn that runway 04 is in use and plan your approach accordingly. Press the **PROC** key and select the “VOR 04-GPS” approach. From the transitions window, select LYH VOR (the IAF). Also, select “Load?” to load (but not activate) the approach.

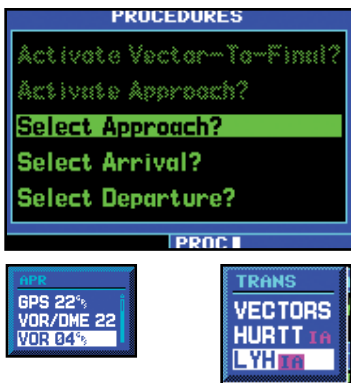

- Once you are cleared for the approach, press the **PROC** key, select "Activate Approach?" and press **ENT**.

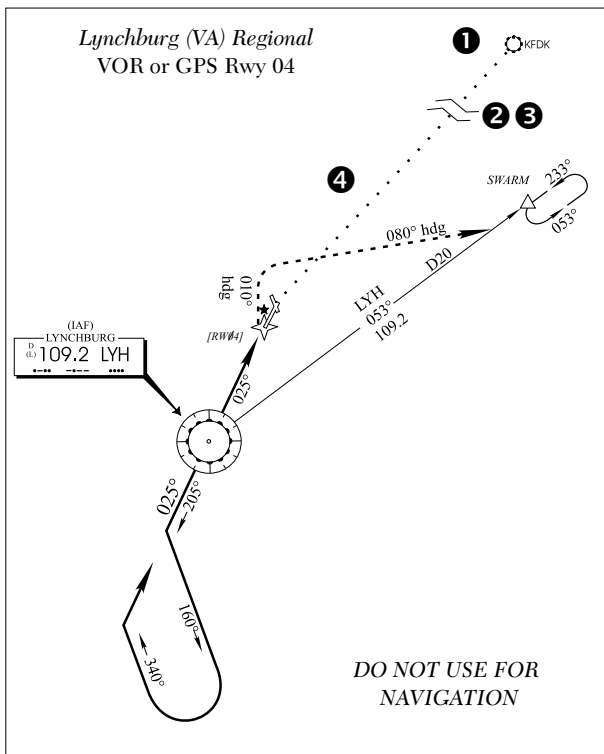

Flying the Procedure Turn

- Within 31 NM of the destination airport, the 400W-series will switch from "en route" mode to "terminal" mode (as indicated in the lower left corner of the screen). The switch to terminal mode is accompanied by a gradual Course Deviation Indicator (CDI) scale transition from 2.0 to 1.0 NM, full scale deflection. (See example below)

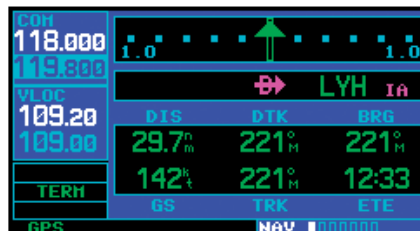

- Several miles prior to reaching the IAF (LYH), you may wish to review the approach sequence. Press the **FPL** key to display the active flight plan page. Press the **small right** knob, and then turn the **large right** knob to review each segment of the approach. When finished, press **FPL** again to return to the previous page.



5 - PROCEDURES

Procedure Turn Approach

- As you approach the IAF (LYH), a waypoint alert ("LT TO 205° x S") will appear in the lower right corner of the screen. As the distance (DIS) to the IAF approaches zero, the alert is replaced by a turn advisory ("LT TO 205° NOW"). The unit will guide you automatically, or you can dial the outbound course of 205° into the CDI (or HSI) using the **OBS** knob and initiate a standard rate turn to this course heading.



- Fly the outbound course, keeping the CDI needle centered.
- Once you have flown approximately one minute past the FAF (LYH), the alert message "LT TO 160° x S" will appear in the lower right corner of the screen. The unit will sequence to the inbound leg when established inbound.



NOTE: You may manually perform any type of procedure turn in accordance with the AIM and the charted procedure. However, the unit displays a map of, and provides roll steering for, a 45/180 procedure turn. If you manually complete the entire procedure turn prior to the unit's initial outbound turn alert, software versions prior to 3.20 may sequence to the inbound leg but enter **SUSP** mode. In that case, press the **OBS** key to resume automatic sequencing.

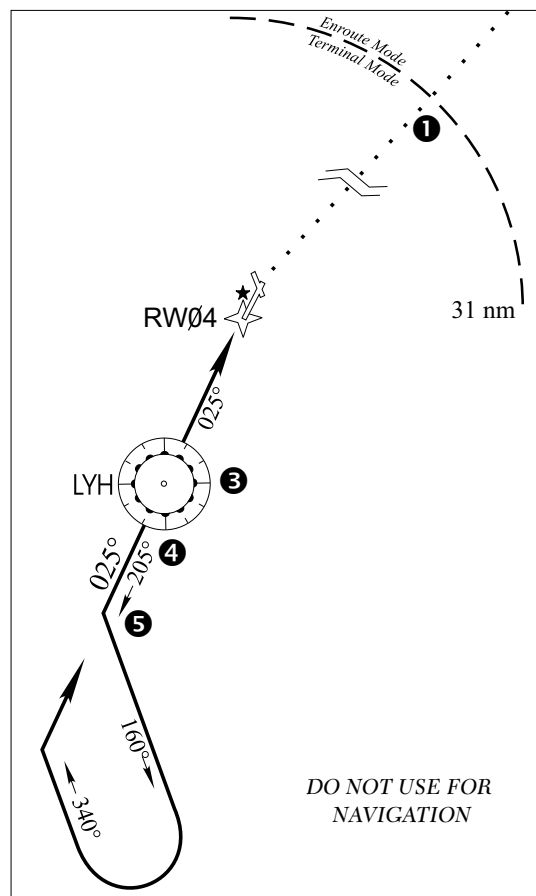

- Turn left to a heading of 160° to initiate the procedure turn. Course guidance is provided relative to the outbound leg from the FAF. (The procedure turn is displayed on the map page and indicated as the active leg on the default NAV and active flight plan pages.) The CDI needle will start moving to the right.

- After approximately one minute, make a 180° right turn to a heading of 340° to intercept the inbound course. The unit will sequence to the inbound leg to the FAF, the CDI needle will swing to the opposite side to provide proper sensing along the final course segment and “DTK 025° NOW” will appear in the lower right corner of the screen.



- As the CDI needle starts to center, make a right turn to 025°—the final approach course.
- When within 45° of the final approach course and the FAF is the TO waypoint, the 400W-series unit switches from terminal mode to “approach” mode. CDI scaling is tightened from 1.0 NM full scale deflection to either 0.3 NM or 2° full scale deflection whichever is less at the FAF. The change occurs over 2 NM and is completed by the FAF.
- As you approach the FAF, a waypoint alert in the lower right corner (“NEXT DTK 025°”) will appear. Make any course adjustments necessary for the final course segment (FAF to MAP).
- As you cross the FAF, the destination sequences to the MAP (“RW03”, the runway threshold). With the needle centered, fly toward the MAP, observing the altitude minimums dictated by the approach plate.

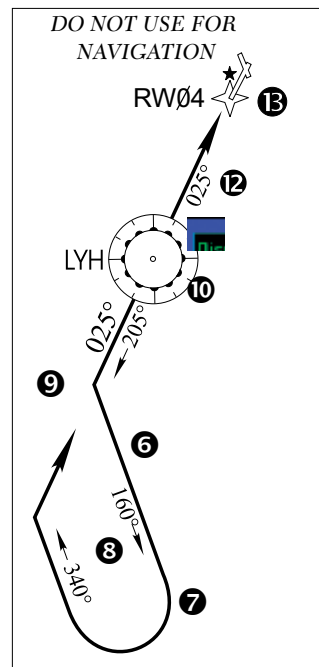

NOTE: When viewing the map page, note that the final course segment is displayed in magenta (the active leg of the flight plan always appears in magenta) and a dashed line extends the course beyond the MAP. The dashed line is provided for situational awareness only and should NOT be used for navigation. Follow the published missed approach procedures.

- As you approach the MAP, a waypoint alert (“ARRIVING WPT”) will appear in the lower right corner.
- As you cross the MAP, “SUSP” will appear above the **OBS** key, indicating that automatic sequencing of approach waypoints will be sus-

5 - PROCEDURES

Missed Approach

pended at the MAP. A “from” indication will be displayed on the CDI and default NAV page, but course guidance along the final approach course will continue. If a missed approach is required, use the **OBS** key to initiate the missed approach sequence.



Flying the Missed Approach

After you pass the MAP, if the runway isn't in sight you must execute a missed approach. The 400W-series continues to give guidance along an extension of the final course segment (FAF to MAP) until you manually initiate the missed approach procedure (as mentioned previously in reference to the “SUSP” advisory).

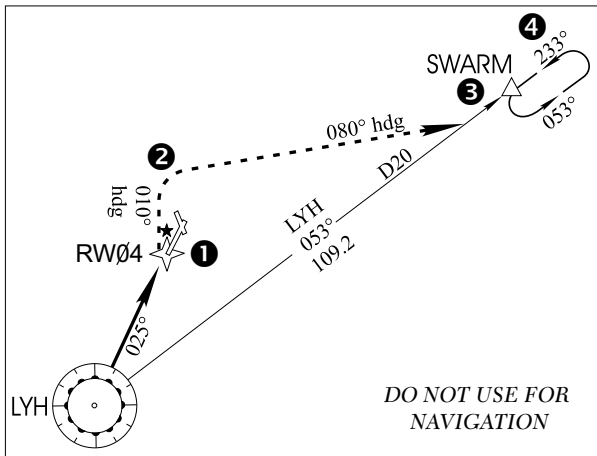

NOTE: It is the pilot's responsibility for initial missed approach guidance in accordance with published procedure. The unit may not provide correct guidance until established on a defined leg.

The **OBS** key is used to initiate the missed approach, as follows:

1. After commencing the published missed approach procedure, and after the SUSP annunciator has appeared, press the OBS key to sequence to the first waypoint in the missed approach procedure. This will simultaneously result in several changes:

- SUSP annunciation will extinguish.
- The first waypoint in the missed approach procedure will be sequenced.
- The current approach annunciation (LPV, L/NAV, LNAV+V, LP, LP +V, or LNAV) will be replaced with either MAPR or TERM, depending on the design of the approach. Normally, MAPR will be annunciated for missed approach procedures in which the first leg is a climb straight ahead to a waypoint, whereas TERM will be annunciated for missed approach procedures requiring a turn.
- CDI scaling will change to ± 0.3 NM full scale deflection if MAPR is annunciated, or ± 1.0 NM if TERM is annunciated.
- The “FROM” indicator will change to a “TO” indication.



NOTE: In some cases, an additional hold waypoint is added to the missed approach sequence. This additional waypoint is used as an aid in establishing the holding pattern—especially where the MAP and MAHP are the same waypoint.

2. An alert message in the lower right hand corner of the screen will recommend entry procedures for the holding pattern (i.e., “HOLD DIRECT”, “HOLD PARALLEL”, or “HOLD TEARDROP”).

As you fly the holding pattern, a timer appears on the default NAV page. The timer automatically resets on the outbound side of the hold when you are abeam the hold waypoint. The timer again resets as you turn inbound (within approximately 30° of the inbound course). This allows you to use standard timing (typically one minute) to fly the inbound and outbound legs of the hold.



The 400W-series unit will provide course guidance only on the inbound side of the holding pattern. When leaving the holding pattern to re-fly the approach (or another approach) press the **PROC** key to "Select Approach?" or "Activate Approach?" as previously described. (Or, use the **direct-to** key to select another destination.)

Flying an Approach with a Hold

Starting where the previous example left off, we'll assume weather conditions resulted in a missed approach at Lynchburg Regional. Now, you've decided to divert to Farmville Regional (KFVX) instead.

1. Press **direct-to**.

2. Use the **small** and **large right** knobs to enter the destination airport's identifier (KFVX).

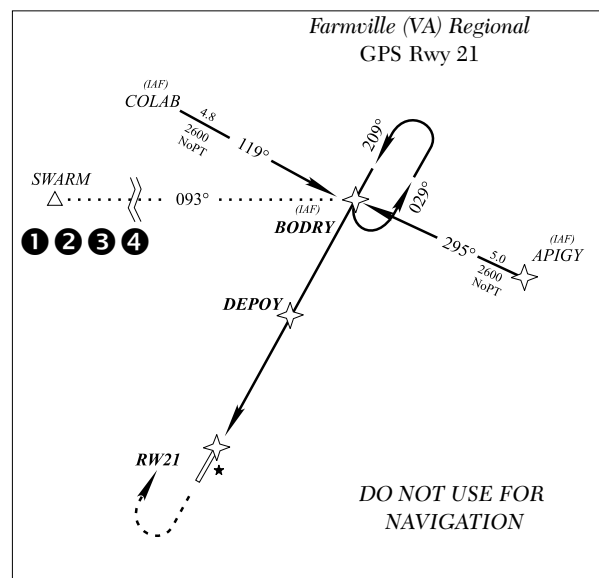
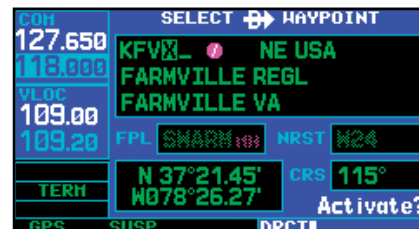

3. Press **ENT** twice.

This time, you select the GPS runway 21 approach into Farmville Regional. The GPS runway 21 approach begins with a holding pattern at the IAF, BODRY intersection.

4. Press **PROC** and select the "GPS 21" approach.

5 - PROCEDURES

Approach with Hold

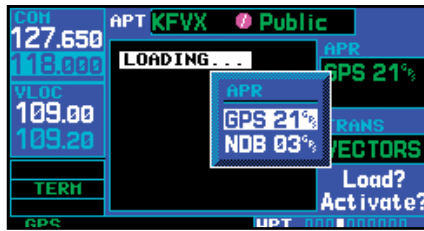

- From the transitions window, select BODRY intersection as the IAF. Also, select "Activate?" to load and activate the approach.

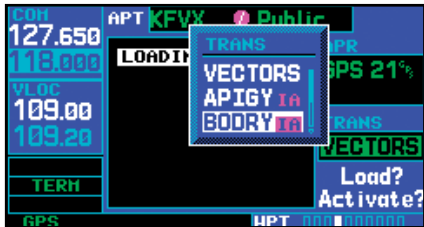

- Once you activate the approach, the active flight plan page will appear. You may review the approach sequence by pressing the **small right** knob and turning the **large right** knob. Press **FPL** to return to the navigation pages.

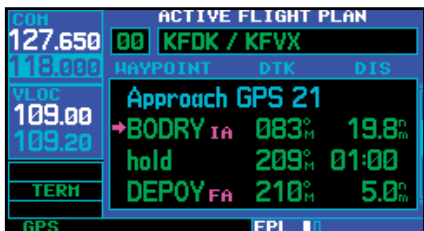

- As in the last example, within 31 NM of the airport, the 400W-series unit will switch from en route mode to terminal mode, and the CDI scale will transition from 2.0 to 1.0 NM, full scale deflection.



NOTE: Upon activating an RNAV GPS approach, you are given the option to skip any non-required holding patterns during the initial transitions of the approach. In a GPS approach, you will not be

given the option and you must manually reselect waypoint sequencing.

- Just prior to crossing BODRY intersection, an alert—"HOLD TEARDROP"—will appear in the lower right corner of the screen to suggest the proper holding pattern entry. ("HOLD DIRECT" or "HOLD PARALLEL" may be offered on other similar approaches.)

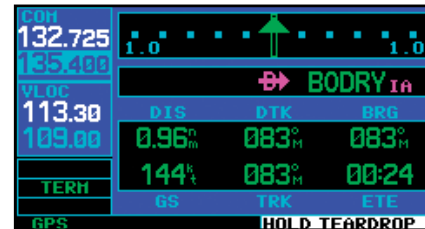

- As mentioned in the missed approach example, the default NAV page will display a timer or distance, as appropriate, during the holding pattern. Use this timer or distance to fly the outbound portion of the holding pattern. (The holding pattern is displayed on the map page and indicated as the active leg on the default NAV and active flight plan pages.)

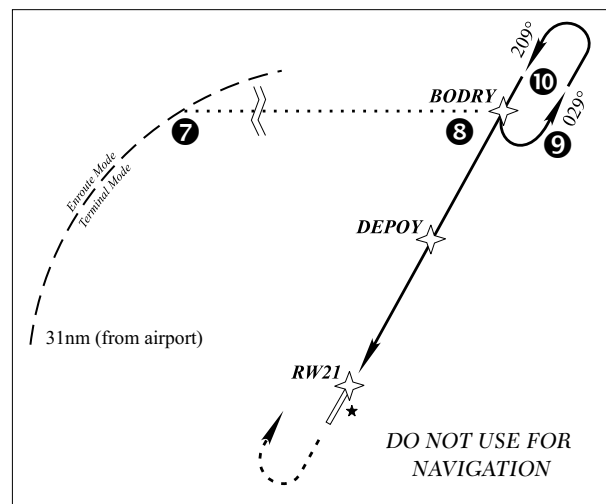

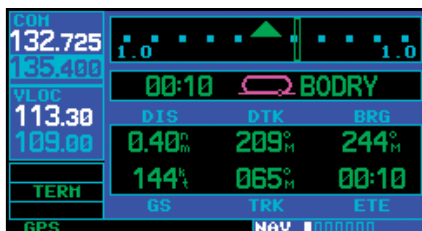

NOTE: If you need to lose extra altitude or speed by going around the holding pattern again, press **OBS** to manually suspend waypoint sequencing **BEFORE** crossing the holding waypoint the second time. If you've already passed this waypoint, re-activate the holding pattern.

- Also as you approach BODRY intersection, a waypoint alert ("NEXT DTK 209°") will appear in the lower right corner of the screen.



- When within 45° of the final approach course and the FAF is the TO waypoint. CDI scaling is tightened from 1.0 NM full scale deflection to either 0.3 nautical mile or 2° full scale deflection whichever is less at the FAF. The change occurs over 2 NM and is completed by the FAF.
- As you approach the FAF, a waypoint alert in the lower right corner ("NEXT DTK 209°") will appear. Make any course adjustments necessary for the final course segment (FAF to MAP).



- As you cross the FAF, the destination sequences to the MAP ("RW21", the runway threshold). With the needle centered, fly toward the MAP, observing the altitude minimums dictated by the approach plate. (When viewing the map page, you'll note that the final course segment is displayed in magenta—the active leg of the flight plan always appears in magenta—and a dashed line extends the course beyond the MAP. Do NOT follow this extended course. Instead, follow published missed approach procedures.)

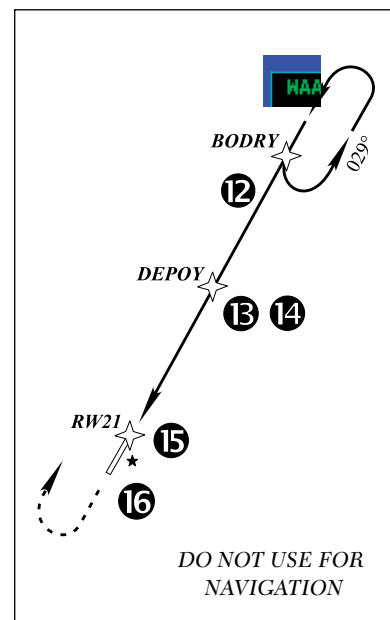

5 - PROCEDURES

DME Arc Approach

- As you approach the MAP, a waypoint alert (“ARRIVING WPT”) will appear in the lower right corner. CDI scaling continues to tighten from 0.3 NM to 350 feet, full-scale deflection.
- As you cross the MAP, “SUSP” will appear above the **OBS** key, indicating that automatic sequencing of approach waypoints will be suspended at the MAP. A “from” indication will be displayed on the CDI and default NAV page, but course guidance along the final approach course will continue. If a missed approach is required, use the **OBS** key to initiate the missed approach sequence.



Flying a DME Arc Approach

The GPS overlay for a DME arc approach uses additional Jeppesen-provided waypoints to define the arc. These waypoints are indicated by “D” as the first letter in the waypoint name. This is followed by three numbers which indicate the radial the waypoint lies on. The last letter indicates the radius of the arc.

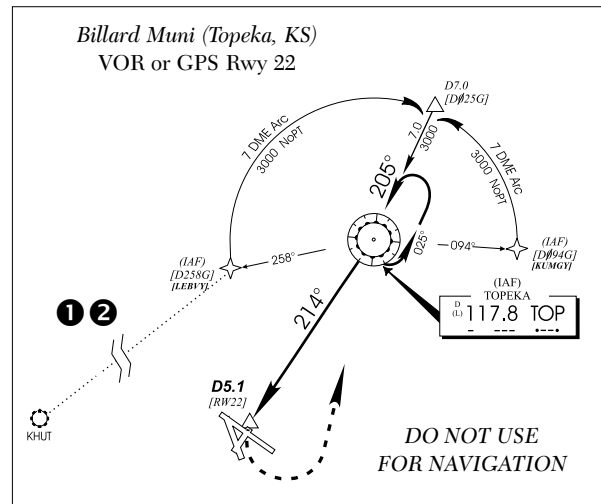

NOTE: The letter/number DME arc names are being replaced with standard five-letter intersection names. You may encounter either naming convention for an approach you select.

This example is based upon a flight from Hutchinson (Kansas) Municipal (KHUT) to Billard Municipal (KTOP) in Topeka, Kansas. The VOR/DME runway 22 approach will be selected, along with “D258G” as the IAF.

- Select Billard Muni (KTOP) as your destination, via the **Direct-To** key or as the last waypoint in a flight plan.



- Press the **PROC** key and select the “VOR 22” approach. From the transitions window, select “LEBVY” as the IAF. Also, select “Load?” (or “Activate?”, if already cleared direct to the IAF for the approach).

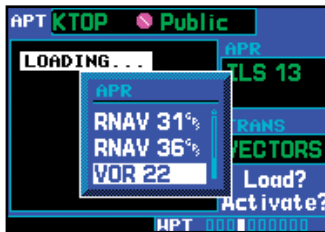
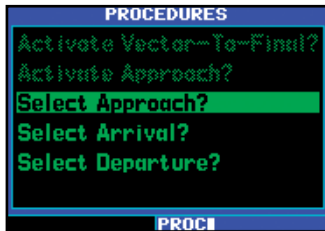

- Within 31 NM of KTOP, the 400W-series unit will switch from en route mode to terminal mode and the CDI scale will transition from 2.0 to 1.0 NM, full scale deflection.

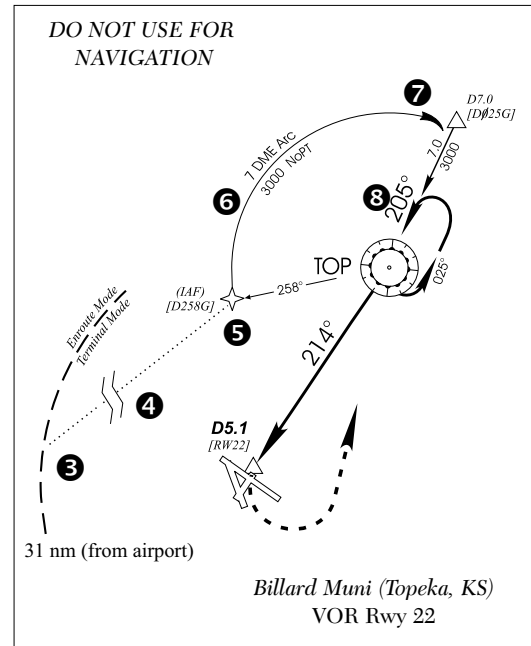

- If you haven't already activated the approach (in step #2 above), be sure to do so when cleared for the approach.

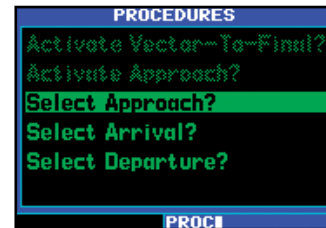

- As you approach the IAF (LEBVY/D258G), a waypoint alert (“LT TO 350° x S”, meaning turn left to 350° in x seconds) will appear in the lower right corner of the screen. As the distance (DIS) to the IAF approaches zero, the alert is replaced by a turn advisory (“LT TO 350° NOW”).

5 - PROCEDURES

DME Arc Approach



- Follow the arc, keeping the CDI needle centered. When using an autopilot, the course select on the CDI (or HSI) must be periodically updated with the desired track (DTK) to ensure proper tracking through the arc. Whenever the course select setting and desired track differ by more than 10°, a "Set course to ###°" message will appear on the message page.
- The next point in the approach is an intermediate fix, labeled "DMARY/D025G". As you approach this intermediate fix, a waypoint alert ("RT TO 205° x S") will appear in the lower right corner of the screen. As the distance to this fix approaches zero, the alert is replaced by a turn advisory ("RT TO 205° NOW"). Dial this course into the CDI (or HSI) using the **OBS** knob and initiate a standard rate turn to this course heading.



- When within 45° of the final approach course and the FAF is the TO waypoint, the 400W-series unit will switch from terminal mode to approach mode. CDI scaling is tightened from 1.0 NM full scale deflection to either 0.3 NM or 2° full scale deflection whichever is

less at the FAF. The change occurs over 2 NM and is completed by the FAF.

- As you approach the FAF, "RT TO 214° x S" will appear in the lower right corner of the screen. Select this course on the CDI (or HSI) using the **OBS** knob and turn to the final course segment (FAF to MAP) heading.

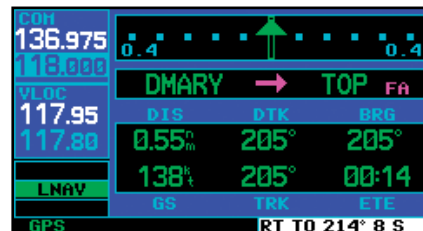
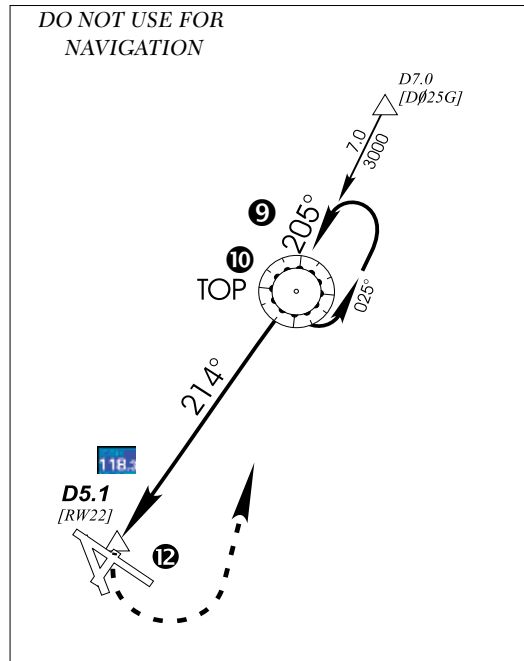

NOTE: Since this is not a GPS approach, the pilot should be using the VLOC receiver, tuned to the correct VOR (TOP) for navigation.

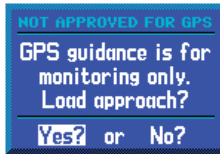

- As you cross the FAF, the destination sequences to the MAP ("RW22", the runway threshold). With the needle centered, fly toward the MAP, observing the altitude minimums dictated by the approach plate. When viewing the map page, you'll note that the final course segment is displayed in magenta (the active leg of the flight plan always appears in magenta) and a dashed line extends the course beyond the MAP.



- As you approach the MAP, a waypoint alert ("ARRIVING WPT") will appear in the lower right corner. CDI scaling continues to tighten from 0.3 NM to 350 feet, full-scale deflection.
- As you cross the MAP, "SUSP" will appear above the **OBS** key, indicating that automatic sequencing of approach waypoints will be suspended at the MAP. A "from" indication will be displayed on the CDI and default NAV page, but course guidance along the final approach course will continue. Do NOT follow this extended course. Follow published missed approach procedures using the **OBS** key to initiate the missed approach sequence.

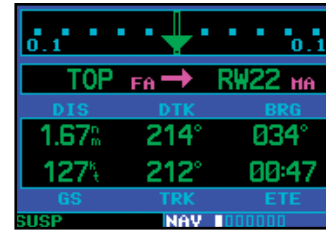

Vectors to Final

Let's take a second look at the "VOR 22" approach into Billard Municipal. Instead of following the DME arc, ATC tells you to expect vectors onto the final approach course. There are several ways to select "vectors to final" with the 400W-series unit. The first two options below will normally require the least workload to accomplish:

- When the approach is first selected, choose "VECTORS" from the transitions window.
- Load a full approach — including the IAF from the transitions window. When cleared, press **PROC** and select "Activate Vectors-To-Final?".
- Load the full approach. Use the **direct-to** key (by pressing it twice) from the active flight plan page to select the desired leg of the approach.

To select "VECTORS" from the transitions window:

- Select Billard Municipal (KTOP) as your destination, using the **direct-to** key, or as the last waypoint in a flight plan.
- Press the **PROC** key and select the "VOR 22" approach.
- From the transitions window, select "VECTORS".

5 - PROCEDURES

Vectors-To-Final Approach



4. Select "Load?" (or "Activate?", if already on vectors-to-final).

To activate vectors-to-final from the procedures page:

1. Select Billard Municipal (KTOP) as your destination, using the **direct-to** key or as the last waypoint in a flight plan.
2. Press the **PROC** key and select the "VOR 22" approach.
3. From the transitions window, select "LEBVY" as the IAF. Also, select "Load?".



4. When cleared, press the **PROC** key and select "Activate Vector-To-Final?".

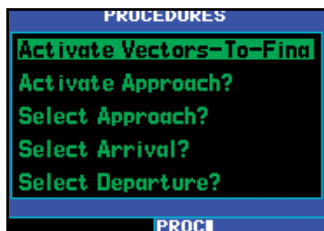

Flying the Vectors Approach

With "vectors to final" selected, the CDI needle will remain off center until you're established on the final approach course. With the approach activated, the *map page* will display an extension of the final approach course in magenta (remember, magenta is used to depict the active leg of the flight plan) and "VTF" will appear as part of the active leg on the *default NAV page* (as a reminder that the approach was activated with vectors-to-final). In this example, we'll assume ATC vectors result in a rectangular course to intercept final, as follows:

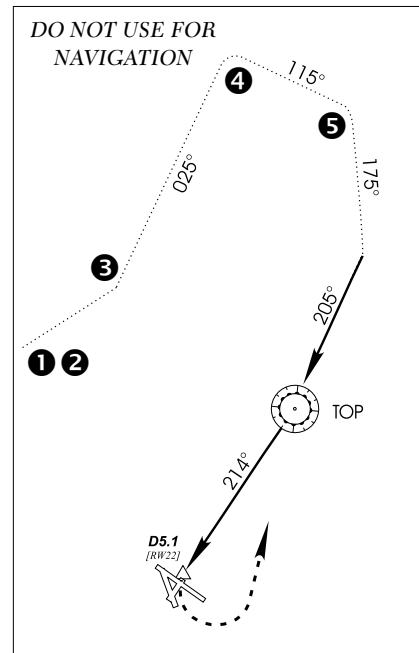

1. When VTF is activated, the 400W-series unit switches to approach mode and course guidance is given along the final approach course. CDI full-scale deflection is as shown in Appendix C.

- The unit suspends automatic waypoint sequencing in this case, because VTF was activated while on the "From" side of the Final Approach Fix.
- ATC instructs you to turn left to a heading of 025°. This places you parallel to the final approach course in the opposite direction. CDI needle deflection is to the left.

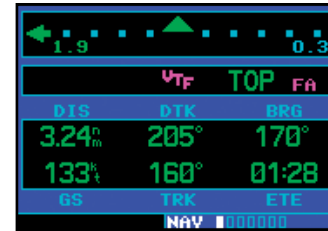

- As the CDI needle centers, make any remaining course corrections to establish yourself on the final approach course.



- ATC instructs you to turn right to a heading of 115°.

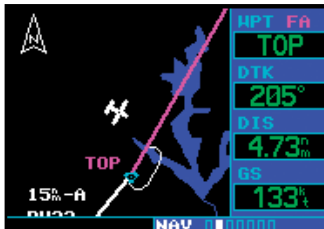

- ATC instructs you to turn right to a heading of 175° to intercept the final approach course. As you converge with the final approach course the needle moves toward the center. (In the illustration below, the needle has returned to the on-screen CDI and your current position is less than 0.5 NM right of the final approach course.) Once the aircraft is within the approach course and the CDI is active, automatic waypoint sequencing resumes and SUSP is removed.

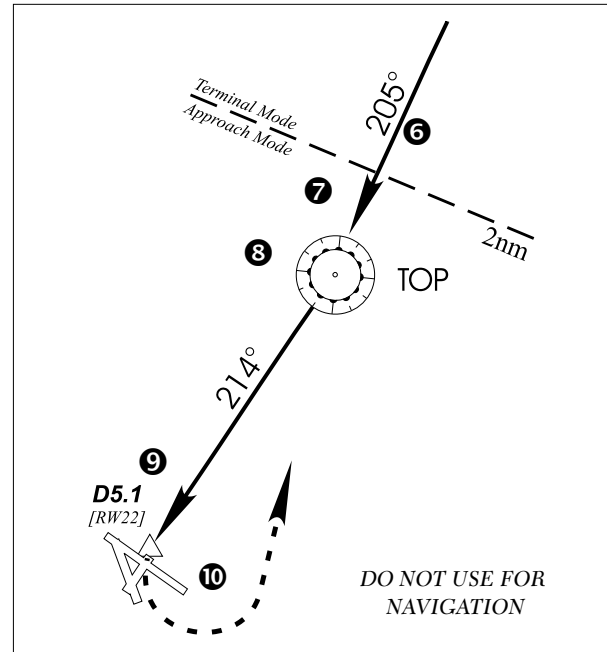

- As you approach the FAF, a waypoint alert in the lower right corner ("Next DTK 214° in xx sec") appears. Make any course adjustments necessary for the final course segment (FAF to MAP). After the FAF, VLOC guidance should be used for this approach. LNAV remains annunciated to indicate on-screen CDI sensitivity.

5 - PROCEDURES

Course-From-Fix Legs

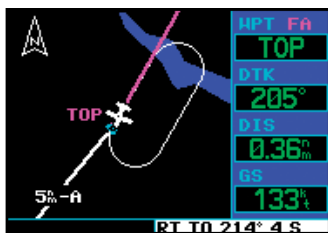

8. As you cross the FAF, the destination sequences to the MAP ("RW22"). With the needle centered, fly toward the MAP, observing the altitude minimums dictated by the approach plate. On-screen CDI scaling continues to tighten to 350 feet, full-scale deflection.
9. As you approach the MAP, a waypoint alert ("ARRIVE WPT") appears in the lower right corner.
10. As you cross the MAP, "SUSP" appears above the **OBS** key, indicating that automatic sequencing of approach waypoints is suspended at the MAP. A "from" indication is displayed on the CDI and Default NAV Page, but course guidance along the final approach course continues. Do NOT follow this extended course. Follow published missed approach procedures using the **OBS** key to initiate the missed approach sequence.

Course From Fix Flight Plan Legs

Certain approach, departure, and arrival procedures in the Jeppesen database contain *course from fix* flight plan legs. The 400W-series is able to load these legs into the flight plan along with the rest of the procedure data, and to provide navigation along these legs.

There are three different types of course from fix legs:

TYPE 1: Course from fix to distance, or Course from fix to DME distance

Course from fix to distance legs will appear in the flight plan like normal waypoints, but the destination

name will always begin with a "D", followed by a distance in tenths of nautical miles from the waypoint fix. This example uses the VOR/DME RWY 25 approach into Palmdale, California (KPMD) and includes a teardrop course reversal.

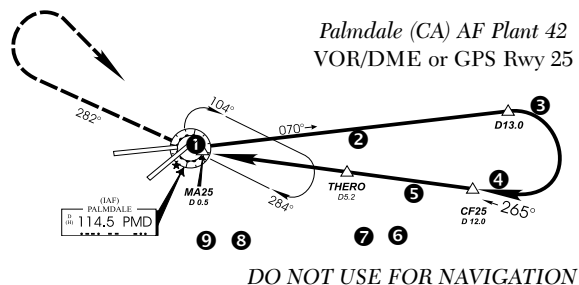

1. As you reach the initial approach fix (PMD), a waypoint alert ("RT TO 070° x S") will appear in the lower right corner of the screen. As the distance to the IAF approaches zero, the alert is replaced by a turn advisory ("RT TO 070° NOW"). Dial the outbound course into the CDI (or HSI) using the OBS knob and initiate a standard rate turn to this course heading.
2. Fly the outbound course, keeping the CDI needle centered. You are now on the "course from fix to distance" leg, as shown on the

active flight plan and default NAV pages. Note the magenta line in the bottom figure, which represents the currently active leg of the approach. The distance (DIS) displayed on the above screens is TO the “D13.0” point. The flight plan will automatically sequence to the next leg upon reaching “D13.0”.



- At 13.0 NM from the IAF, a waypoint alert (“DTK 265° x S”) will appear in the lower right corner of the screen. Make a standard rate turn to the right to intercept the final approach course and watch for the CDI needle to begin to center.
- As you approach the intermediate fix (CF25), a waypoint alert (“DTK 265° x S”) will appear. Make any necessary course adjustments.
- Approach is active when the FAF is the TO waypoint and bearing and track are within 45° of the final approach course. The 400W-series unit will switch from terminal mode to approach mode. (“LNAV” will appear in the lower left corner of the screen—replacing “TERM”.) CDI scaling will be tightened from 1.0 to 0.3 NM full scale deflection, or 2° full scale deflection, whichever is less at the FAF, and as defined for the approach. The change occurs over 2 NM and is completed by the FAF.
- As you approach the FAF, “DTK 265° x S” will appear in the lower right corner of the screen.

- As you cross the FAF, the destination sequences to the MAP (MA25). With the CDI needle centered, fly toward the MAP, observing the altitude minimums dictated by the approach plate.
- As you approach the MAP, a waypoint alert (“ARRIVING WPT”) will appear in the lower right corner of the screen. The CDI will continue to tighten to ± 350 feet full-scale deflection.
- As you cross the MAP, “SUSP” will appear above the **OBS** key, indicating that automatic sequencing of approach waypoints is suspended at the MAP. If a missed approach is required, use the **OBS** key to initiate the missed approach sequence, as outlined below.

TYPE 2: Course from fix to altitude

Course from fix to altitude legs will show the specific target altitude on the active flight plan and default NAV pages. The missed approach sequence for the Palmdale VOR/DME RWY 25 approach includes a *course from fix to altitude* leg. In this instance, the leg corresponds to the initial phase of the missed approach, which reads “Climb to 5000’ outbound via PMD VOR R-282”.



- After crossing the MAP, press the **OBS** key. The missed approach sequence is automatically offered, starting with the course from fix to altitude leg. The “DTK 282° NOW” alert appears in the lower right corner of the screen. Follow the missed approach procedures, as published

5 - PROCEDURES

Course-From-Fix Legs

on your approach plate, for proper climb and heading instructions.

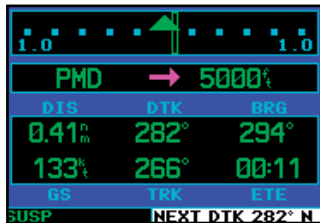

- Note that within a few seconds of pressing **OBS** to release suspend mode and start the approach sequence, "SUSP" re-appears above the **OBS** key as the 400W-series unit returns to suspend mode. This is normal when flying a course from fix to altitude leg and indicates that automatic leg sequencing is suspended.



NOTE: If there is a valid baro-corrected pressure altitude input, the *SUSP* is not annunciated and the leg sequences automatically when the altitude (5,000 ft) is reached.

- Fly the outbound course keeping the CDI needle centered. The map page will depict the flight path extending from PMD VOR to 5,000 feet.

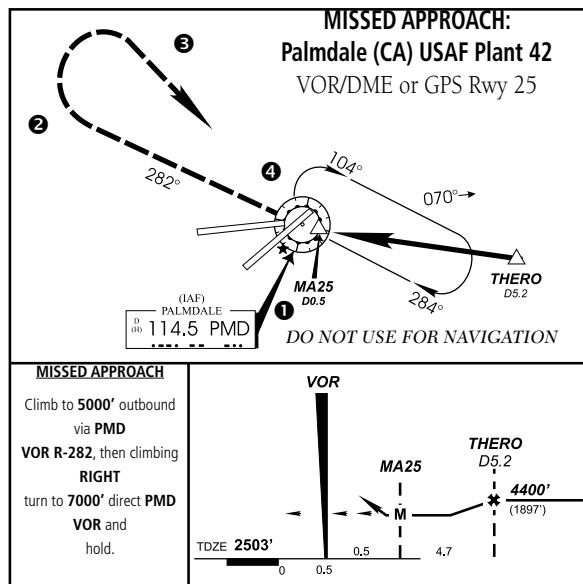

- Upon reaching the desired altitude (5000'), press **OBS** to return to automatic leg sequencing. Confirm that "SUSP" no longer appears directly above the **OBS** key.
- An alert ("DTK 123° NOW") will appear guiding you to the inbound course. The actual desired track (DTK) will depend on your ground speed and distance from PMD VOR. Intercept and fly the inbound course, keeping the CDI needle centered.

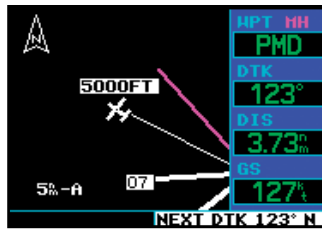

6. As you approach PMD VOR (the missed approach holding point), an alert message in the lower right hand corner of the screen will recommend the holding pattern entry procedure (“HOLD PARALLEL”). As you fly the holding pattern, a timer appears on the default NAV page. The timer automatically resets on each outbound and inbound portion of the holding pattern.
7. Note that the 400W-series unit again displays “SUSP” above the **OBS** key. Automatic waypoint sequencing is suspended at the missed approach holding point. A waypoint alert (“ARRIVING WPT”) appears in the lower right corner of the screen each time you approach PMD VOR in the holding pattern.
8. When leaving the holding pattern, press the **PROC** key to reactivate the approach or select a different approach, or press **direct-to** to select another destination.

TYPE 3: Course from fix to manual sequence

Course from fix to manual sequence legs will appear on the active flight plan and map pages with “man seq” in place of a waypoint identifier. An example of this type of course leg appears in the COASTAL ONE DEPARTURE from Westfield, Massachusetts (Barnes Muni). The example leg corresponds to the departure leg from Barnes Municipal and appears as follows on the active flight plan and default NAV pages:

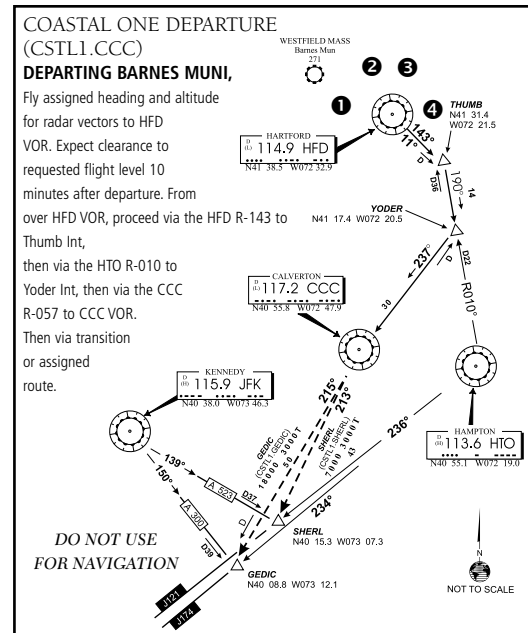

1. Select the departure (CSTL1) from the procedures page. Then select the departure runway (RW02, in this example) and transition (GEDIC).



2. As you depart the airfield, "NEXT DTK 026°" appears in the lower right corner of the screen and "SUSP" appears directly above the **OBS** key. You are now on the "course from fix to manual sequence" leg. The distance displayed on the active flight plan, default NAV and map pages is FROM the waypoint fix (the departure runway, in this example).



3. Fly the outbound course keeping the CDI needle centered. Once you are cleared to sequence to the next leg, press the **OBS** key. Confirm that "SUSP" no longer appears directly above the **OBS** key. An alert ("NEXT DTK 183°") will appear in the lower right corner of the screen to guide you to the next waypoint (HFD VOR). The actual desired track (DTK) will depend on your ground speed and distance from HFD VOR.



4. Once the **OBS** key is pressed, the 400W-series unit will automatically sequence to each waypoint along the remainder of the departure route, including the selected transition.

ILS Approaches

Precision approaches can be performed with the GNS 430W's built-in VLOC (VOR/localizer/glideslope) receivers. The GPS receiver can be used for guidance prior to reaching the final approach fix, but once there, the proper frequency must be selected on the VLOC window (left side of screen) and the CDI output set to "VLOC".

The GNS 430W can be set to automatically switch the external CDI output from GPS to VLOC as you intercept the final approach course (if used with a KAP140/KFC225 autopilot, you will need to manually enable outputs). See instructions at the end of this section. When the ILS approach is activated, the GNS 430W will automatically switch within 1.2 NM left or right of the final approach course. This switch can take place anywhere from 2.0 to 15.0 NM from the FAF.

The illustration at right shows multiple locations along the approach path and which CDI selection you can expect: GPS or VLOC. Within the area of the shaded box, the automatic switch from GPS to VLOC should occur.



NOTE: If you attempt to intercept the approach course at a distance less than 2.0 NM from the FAF, the GNS 430W will not automatically switch the CDI to VLOC. In this case, press the CDI key to manually switch from GPS to VLOC.

430W Only

The automatic switch from GPS to VLOC is not immediate, but instead occurs gradually to prevent abrupt CDI changes when coupled to an autopilot. The CDI selection can also be changed manually by pressing the **CDI** key. Once the switch from GPS to VLOC has occurred, either automatically or manually, it will not automatically switch again until the approach is reactivated or another approach is selected. To prevent automatic ILS CDI selection, choose the “Manual” ILS CDI setting. (The factory default setting is “Auto”, which enables the automatic switch to VLOC.)

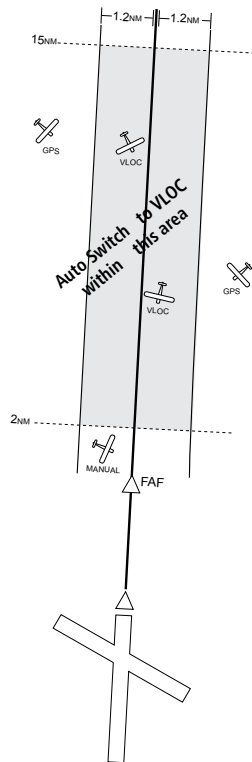

Selecting an ILS Approach

For this example, we'll use a flight from Laughlin Bullhead (Arizona) International to Flagstaff Pulliam (KFLG) and select the ILS runway 21 approach. “SHUTR” intersection will be selected as the IAF, which will include an outbound leg and a procedure turn. Of course, vectors-to-final could also be selected, as previously described for the non-precision approach examples.

1. Select Flagstaff Pulliam (KFLG) as your destination, via the **direct-to** key or as the last waypoint in a flight plan.



2. Press the **PROC** key and select the “ILS 21” approach.

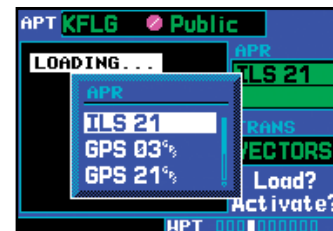

3. From the transitions window, select “SHUTR” as the IAF. Also, select “Load?” (or “Activate?”, if already cleared for the approach).

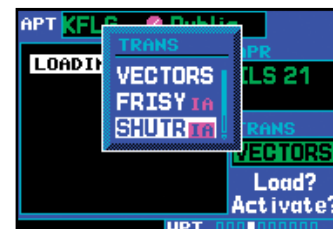

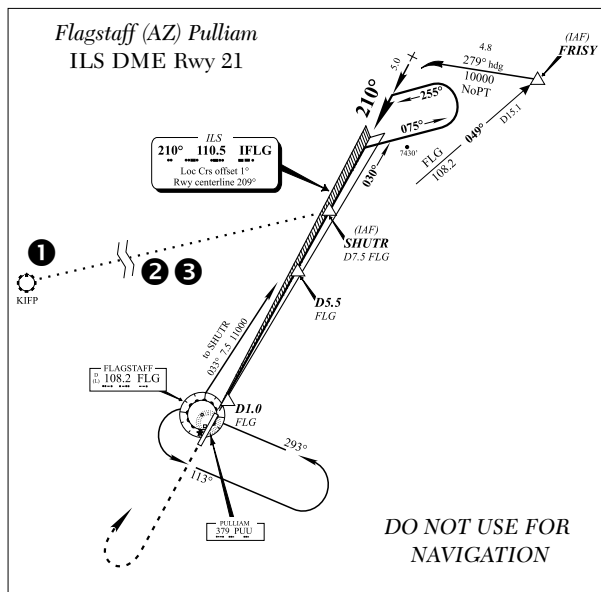

4. A reminder message appears, indicating that GPS can only be used for approach monitoring. As mentioned, you will need to use the VLOC receiver for this approach. Press **ENT** to acknowledge the message.

When you “Load?” (or “Activate?”) an ILS approach, the ILS frequency is automatically placed in the standby field of the VLOC window. To use this frequency, simply press the **VLOC flip-flop** key to place it in the active frequency field.

Flying the ILS Approach

When you “Activate?” an ILS approach, automatic switching of the external CDI is enabled (unless turned off from the CDI/Alarms Page). When you are established on the inbound course to the FAF, the external CDI guidance will automatically switch from “GPS” (shown in green text) to “VLOC” (shown in white text). If you have forgotten to activate the ILS frequency (step #4 below), automatic selection of “VLOC” will not occur.



NOTE: GPS level of service annunciations (LPV, ENR, etc.) are not applicable to the external CDI (or HSI) when VLOC is active.

1. Within 31 NM of KFLG, the GNS 430W will switch from en route mode to terminal mode and the CDI scale will transition from 2.0 to 1.0 NM, full scale deflection.
2. If you haven’t already activated the approach (in steps on previous page), be sure to do so when cleared for the approach.

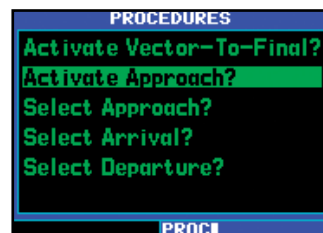

3. As you approach the IAF (SHUTR), a waypoint alert (“LT TO 030° x S”) will appear in the lower right corner of the screen.

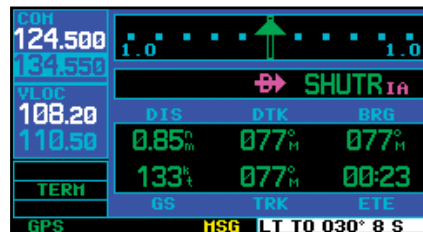

430W Only

- If you haven't already done so, press the **VLOC flip-flop** key to activate the ILS frequency. If you forget this step, the GNS 430W will display a reminder message (within 2 NM of the FAF) to activate the ILS frequency.

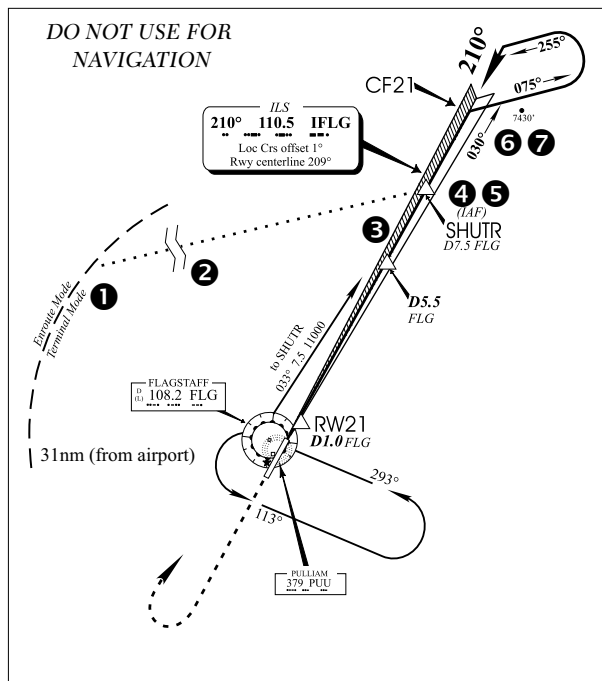

- As the distance (DIS) to the IAF approaches zero, the alert is replaced by a turn advisory ("LT TO 030° NOW").



- Fly the outbound course (030°), keeping the needle centered on the external CDI (or HSI).

- Once you have flown approximately one minute past SHUTR intersection, prepare for the procedure turn.
- Turn right to a heading of 075° to initiate the procedure turn. The GNS 430W will not guide you through the turn. (The procedure turn is displayed on the map page and indicated as the active leg on the default NAV and active flight plan pages.) The external CDI needle will start moving to the left.



- After approximately one minute, make a 180° left turn to a heading of 255° to intercept the ILS. The GNS 430W will sequence to the inbound leg and "DTK 210° NOW" will appear in the lower right corner of the screen. CDI coupling will automatically switch from the "GPS" receiver to the "VLOC" receiver as you complete the inbound turn. (If the ILS frequency has not been activated, per step #4, this automatic CDI switch will not occur.)

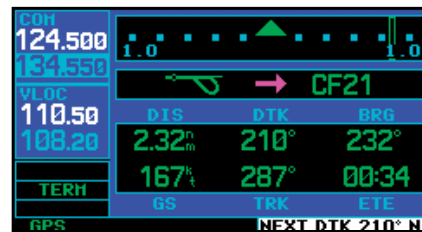

- As the CDI needle starts to center, make a left turn to 210° to track the ILS approach course.

5 - PROCEDURES

ILS Approach

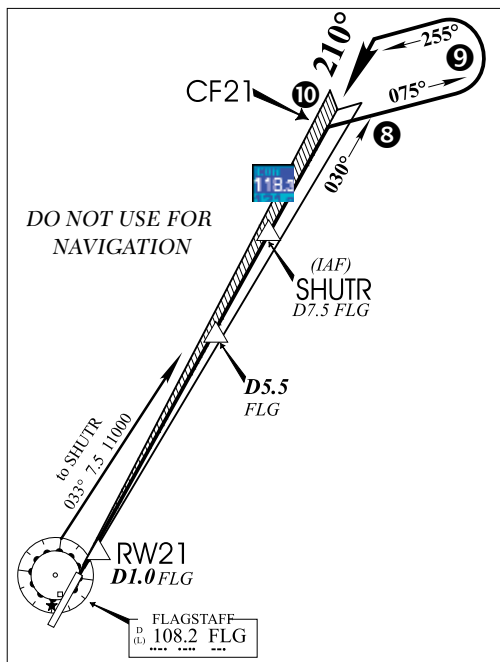

NOTE: From this point on, primary navigation is provided by the VLOC receiver. You may continue to use the GPS receiver for supplemental navigation guidance only. If automatic CDI switching is disabled ("Manual" selected), the reminder message "Select VLOC on CDI for approach" appears at 2.0 NM prior to the FAF. In this instance, you must press CDI to manually switch CDI output to the VLOC receiver and continue the approach.

11. As you approach the FAF (SHUTR), "LNAV" will appear in the lower left corner of the screen—indicating a CDI scale transition from TERM to approach scaling. This scale transition applies only to the default NAV page's on-screen CDI, since the external CDI or HSI is now coupled to the VLOC receiver.
12. Also as you approach SHUTR, a waypoint alert ("DTK 210° x S") will appear in the lower right corner of the screen.



13. As you cross SHUTR, the destination sequences to the MAP ("RW21", the runway threshold). With the needle on the external CDI (or HSI) centered, fly toward the MAP, observing the altitude minimums dictated by the approach plate. (When viewing the map page, you'll note that the final course segment is displayed in magenta—the active leg of the flight plan always appears in magenta—and a dashed line extends the course beyond the MAP.)



14. As you approach the MAP, a waypoint alert ("ARRIVING WPT") will appear in the lower right corner.
15. As you cross the MAP, "SUSP" will appear above the **OBS** key, indicating that automatic sequencing of approach waypoints will be suspended at the MAP.

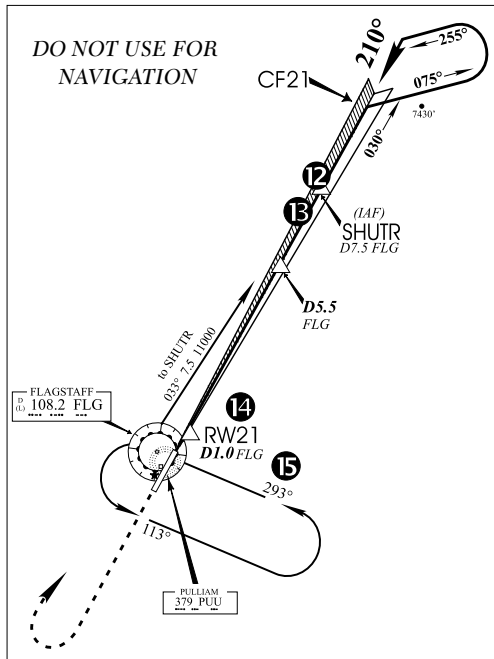

As you cross the MAP, “SUSP” appears above the **OBS** key, indicating that automatic sequencing of approach waypoints is suspended at the MAP. A “FROM” indication is displayed on the Default NAV Page, but course guidance along the final approach course continues. Do NOT follow this extended course. Follow published missed approach procedures using the **OBS** key to initiate the missed approach sequence.



NOTE: In addition to using the **OBS** key to initiate the missed approach sequence, you may wish to press the **CDI** key to manually switch external CDI output to the GPS receiver. “GPS” will be indicated above the **CDI** key.

Selecting an LPV Approach

For this example, we’ll use a flight from Eugene Oregon (KEUG) to Salem Oregon (KSLE) and select the RNAV runway 31 approach. “GLORR” intersection is selected as the IAF. Of course, vectors-to-final could also be selected, as previously described for the non-precision approach examples. An approach plate is shown on the following page.

1. With Salem (KSLE) as your destination in your flight plan, press the **PROC** key and select the “RNAV 31 Z (GPS)” approach.

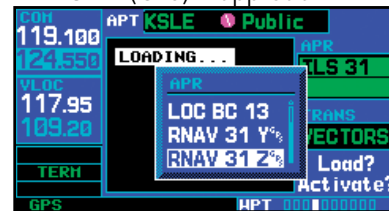

2. From the transitions field, select “GLORR” as the IAF. Review and execute the modified flight plan. Go direct to GLORR when cleared “Direct GLORR” for the approach.
3. Press the **PROC** key to display the Procedures page. With “Load?” highlighted press **ENT** to load the approach into the flight plan.



5 - PROCEDURES

LPV Approach

- After the approach is loaded into the flight plan, you can view the approach waypoints.



- Press the **PROC** key to display the Procedures page. With "Activate?" highlighted press **ENT** to activate the approach.

Flying the LPV Approach

- Within 31 NM of KSLE, the 400W Series unit switches from en route mode to terminal mode and the CDI scale transitions from 2.0 to 1.0 NM, full scale deflection.
- As you approach the IAF (GLORR), a waypoint message ("LT TO 314° x S") appears on the bottom of the screen.

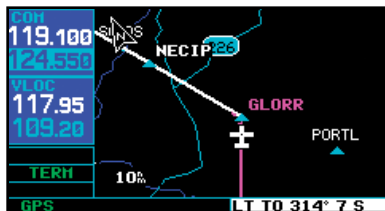

- As the distance (DIST) to the IAF approaches zero, the message is replaced by a turn advisory that counts down 10 seconds prior to the turn.
- As you approach the FAF (LOTKE), the 400W Series unit will begin to automatically rescale in an angular fashion. This will allow the LPV approach to be flown in an identical fashion to a standard ILS. At 2.0 NM from the FAF, CDI scaling is tightened from 1.0 to the angular full scale deflection (typically the angular full-scale deflection is 2.0°, but will be as defined for the approach).

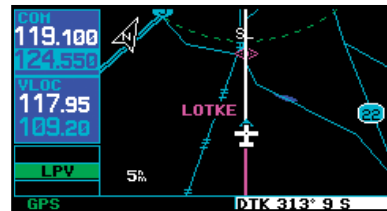

- Sixty seconds prior to reaching the FAF (LOTKE), the unit will check the required Horizontal Alarm Limit (HAL) and Vertical Alarm Limit (VAL) to ensure the GPS position integrity is within limits to complete the LPV precision approach. In the event the HAL or VAL limits are exceeded, the approach will be downgraded to a non-precision approach indicated by "LNAV" on the moving map, a message that the approach is downgraded ("Approach downgraded - Use LNAV minima"), and the glideslope indicator will be flagged. You may continue the approach using LNAV non-precision minimums if there are LNAV minimums for this approach. In the rare event the GPS integrity cannot meet the non-precision HAL limits, the unit will send a message to the pilot to abort the approach ("Abort Approach - Loss of Navigation"). The unit will revert to terminal limits to support navigation to the missed approach when the message is acknowledged. After the aircraft has passed the FAF, a loss of WAAS integrity will cause the approach to abort instead of downgrade.
- Capture the glideslope as you would an ILS glideslope.
- As you cross LOTKE, the destination sequences to the MAP ("RW31", the runway threshold). With the needle on the external CDI (or HSI) centered, fly toward the MAP, observing the altitude minimums dictated by the approach plate.



8. When viewing the Map Page, you'll note that the final course segment is displayed in magenta (the active leg of the flight plan always appears in magenta).
9. As you approach the MAP, a waypoint message ("DTK 312° x S") appears on the bottom of the screen.

10. Once the unit crosses the MAP (defined as the runway end waypoint), sequencing will be suspended. Prepare the aircraft for missed approach operation. Press the **OBS** key to sequence to the Missed Approach procedure.
11. Fly the guidance provided by the unit to the ARTTY intersection and hold.

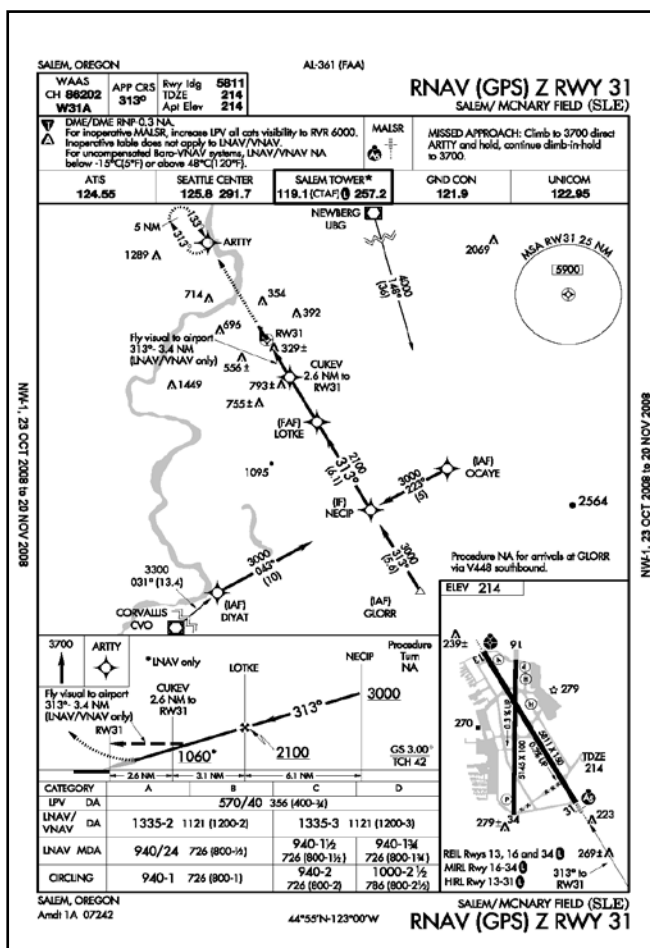

Flying the LP Approach

LP approach capability is available for units with SW Version 3.30, or later. After SW Version 5.10, some LP approaches may provide advisory vertical guidance, indicated as LP +V.

An LP approach is flown similarly to an LNAV approach, except the precision is greater as it utilizes the WAAS accuracy. It has similar lateral accuracy as an LPV approach. Angular scaling is similar to a localizer approach. Most LP approaches have step down altitudes associated with them.

If the approach is indicated as LP +V, advisory vertical guidance will be provided. This does not change how the approach should be flown, and the pilot is still responsible for descending to the correct altitude at each step down. The approach still results in an MDA and missed approach point.

1. Within 30 nautical miles of the destination, the 400W-series unit switches from en route mode to terminal mode and the CDI scale transitions from 2.0 to 1.0 nautical miles, full scale deflection.
2. As you approach the IAF, a turn direction message appears on the bottom of the screen.
3. As the distance (DIST) to the IAF approaches zero, the message is replaced by a time to turn advisory that counts down 10 seconds prior to the turn.
4. As you approach the FAF, the 400W-series unit will begin to automatically rescale in an angular fashion. This will allow the LP approach to be flown in the same fashion as a standard localizer approach. At 2.0 nautical miles from the FAF, CDI scaling is tightened from up to either 2° or 0.3 nautical miles, full scale deflection, whichever is smaller.
5. Sixty seconds prior to reaching the FAF, the 400W-series unit will check the required Horizontal Alarm Limit (HAL) to ensure the GPS position integrity is within limits to complete the LP non-precision approach. In the event
6. the HAL limits are exceeded, the approach will be downgraded, when available, indicated by "LNAV" on the moving map, otherwise the approach will be aborted. A message will note that the approach is downgraded and the NAV indicator will be flagged. You may continue the approach using LNAV non-precision minimums if there are LNAV minimums for this approach. In the rare event the GPS HAL limits cannot meet non-precision limits, the 400W-series unit will notify the pilot with a message to abort the approach. The 400W-series unit will revert to terminal limits of 1.0 NM to support navigation to the missed approach. If the approach is indicating an LP +V, it is possible that the advisory vertical guidance could be removed without annunciation due to the vertical guidance not being within tolerances. This does not constitute a downgrade, and the approach can still be flown to LP minimums.
7. As you cross the FAF, the destination sequences to the MAP. With the needle on the external CDI (or HSI) centered, fly toward the MAP, observing the altitude minimums dictated by the approach plate.
8. When viewing the Map Page, you'll note that the final course segment is displayed in magenta (the active leg of the flight plan always appears in magenta).
9. As you approach the MAP, a waypoint message ("Arriving at Waypoint") appears on the bottom of the screen.
10. At the MAP initiate the missed approach, if necessary. Once the 400W-series unit crosses the MAP sequencing will be suspended. Prepare the aircraft for missed approach operation. Press the **OBS** key to sequence to the Missed Approach procedure.



NOTE: For missed approaches with heading legs, fly manually until the first active course leg is reached, as described in earlier sections.

10. Fly the guidance provided by the 400W-series unit to the MAHP and hold.

RNAV Approach Procedures

The GNS 400W Series allows for flying LNAV, LNAV/VNAV, LNAV + V, LP, LP +V, and LPV approaches according to the published chart.

| HSI Annunciation | Description | Minimums |
|------------------|---|-------------------------------|
| L/VNAV | Lateral Navigation/Vertical Navigation. RNAV non-precision approach with vertical guidance. | Published LNAV/VNAV minimums. |
| LNAV | Lateral Navigation. RNAV non-precision approach. | Published LNAV minimums. |
| LNAV + V | Lateral Navigation with Advisory Vertical Guidance. RNAV non-precision LNAV approach with advisory vertical guidance. The glidepath is typically denoted by a light dashed line on the vertical profile (Jeppesen only) with an associated glidepath angle (usually in the 3.00 degree range) and is provided to assist the pilot in maintaining a constant vertical glidepath, similar to an ILS glideslope. | Published LNAV minimums. |
| LPV | Localizer Performance with Vertical guidance (LPV) approach. RNAV precision approach. | Published LPV minimums. |
| LP | LP indicates Localizer Performance with no vertical guidance. | Published LP minimums. |
| LP +V | LP +V indicates Localizer Performance with advisory vertical guidance. This annunciation is available in SW Ver 5.10, or later. This advisory guidance follows the same nature as set by the LNAV +V as shown above. | Published LP minimums. |



NOTE: Minimums will be controlling, do not descend below applicable minimum descent altitude or decision height until criteria of FAR 91.175 are met.

Points to Remember for All Approaches

- The GNS 400W-series unit is designed to complement your printed approach plates and vastly improve situational awareness throughout the approach. However, you must always fly an approach as it appears on the approach plate.
- The active leg (or the portion of the approach currently in use) is depicted in magenta on the Map Page. As you fly the approach, the 400W-series unit automatically sequences through each leg of the approach unless “SUSP” appears above the OBS key. “SUSP” indicates that automatic sequencing of approach waypoints is *suspended* on the current leg and normally appears at holding patterns and upon crossing the missed approach point (MAP).



- For roll steering autopilots: roll steering is terminated when approach mode is selected on the autopilot and is available once the missed approach is initiated.
- If Vectors-to-Final is activated while on the “FROM” side of the FAF, automatic waypoint sequencing is suspended and the SUSP annunciation will appear. Automatic waypoint sequencing will resume once the aircraft is on the “TO” side of the FAF and within

5 - PROCEDURES

Points to Remember

full-scale deflection. *This is a new feature with the 400W-series.*

- For all approaches and departures, make sure to recheck the runway, transition, and all waypoints. If ATC directs you to make a change, recheck each element again.

Points to Remember for Localizer or VOR-based Approaches

- The default factory setting allows the CDI output to automatically switch from the GPS receiver to the LOC receiver. This may be changed to manual in some installations. If the “ILS CDI Selection” setting is changed to “Manual”, *you* must determine when to select “GPS” or “VLOC” guidance during the approach. Remember, “VLOC” is required for the final course segment from Final Approach Fix (FAF) to MAP.

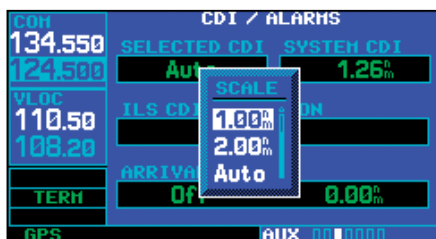

NOTE: Installations with certain autopilots, such as the KAP 140 and KFC225, do not allow automatic ILS CDI switching.



NOTE: GPS level of service annunciations (LPV, ENR, etc.) are not applicable to the external CDI (or HSI) when VLOC is active.

- If the CDI output has not automatically switched from GPS to ILS upon reaching the FAF, you must manually switch to the VLOC receiver by pressing the **CDI** key. Verify that “VLOC” is displayed directly above to the **CDI** key.
- Automatic switching of CDI output is available for ILS, localizer, SDF and LDA approaches. Automatic CDI switching is *not* available for backcourse approaches or VOR approaches.

- When flying an approach with the autopilot coupled, you must monitor system functions at all times and verify that the autopilot and external CDI (or HSI) switch to the VLOC receiver with sufficient time to capture and track the approach course. Switching to “VLOC” late in the approach may not provide the autopilot enough time to respond and intercept the approach course prior to the FAF (depending upon the performance characteristics of your autopilot and aircraft). In such instances, you should manually fly the approach or refer to the documentation provided with your autopilot.
- When an ILS or VOR approach is first selected or executed, the frequency is automatically checked. If the frequency is correct, you will not receive a message regarding the frequency. If the frequency is incorrect, you will receive a message and you must place the ILS or VLOC frequency in the active frequency field.



- When flying a localizer-based approach (other than backcourse) with automatic CDI switching enabled:
 1. “GPS” guidance may be used while flying outbound and on the initial portion of the procedure turn.
 2. “VLOC” guidance is used on the remainder of the approach from the time you turn inbound on the procedure turn.
 3. The localizer frequency must be active to use “VLOC” guidance at the MAP. Press the CDI key to switch back to GPS data when the missed approach is initiated.

- When flying a localizer-based approach with automatic CDI switching disabled:

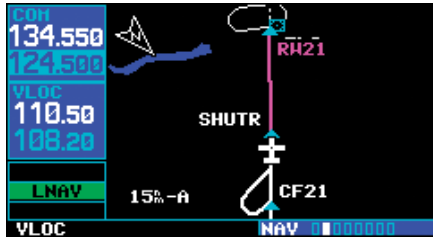

- You may select "VLOC" guidance at any point on the approach prior to reaching the FAF.
- The localizer frequency must be active to use "VLOC" guidance.

Enabling Autopilot Outputs for the King KAP140/KFC225

Autopilot outputs for the King KAP140/KFC225 autopilots are activated manually by the pilot after being prompted during the approach procedure. After enabling outputs, the 400W-series unit will provide guidance information consistent with what the autopilot expects (i.e., angular CDI scaling and glideslope capture for an LPV or other vertically guided GPS approach).

Conditions for autopilot outputs

- The 400W-series unit must be configured during installation to interface with these autopilots and using "Prompt" for GPS Select.
- Guidance to the FAF is active as indicated by Approach mode annunciation (LNAV, LNAV+V, L/VNAV, LP, LP +V, or LPV).

To enable autopilot outputs

- Load and activate approach information as usual.
- When you are turned on course to the FAF (Track and Desired Track are within 10°), a message

will prompt you to enable the autopilot outputs before using your autopilot for an approach.

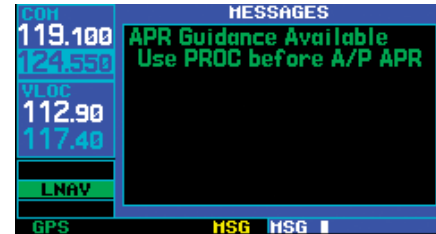

- Press **PROC**. Highlight "Enable A/P APR Outputs?" with the **large right** knob, if necessary, and press ENT.

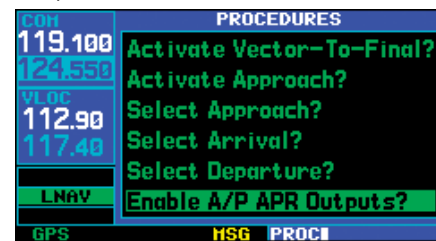

- Press the Approach button on the autopilot to switch it to Approach mode. Your autopilot will now use guidance from the 400W-series unit for the approach.

Blank Page

Section 6 WPT Pages

WPT Page Group

The Waypoint (WPT) page group provides information about the thousands of airports, VORs, NDBs, intersections, runways, frequencies, and procedures stored on your Jeppesen NavData® card. A WPT page is also provided to display information for up to 1,000 user-created waypoints.

To quickly select a WPT page:

1. From any page, press and hold **CLR** to select the default NAV page. (You may skip this step if you are already viewing any of the main pages.)
2. Turn the **large right** knob to select the WPT page group. "WPT" will appear in the lower right corner of the screen.
3. Turn the **small right** knob to select the desired WPT page.

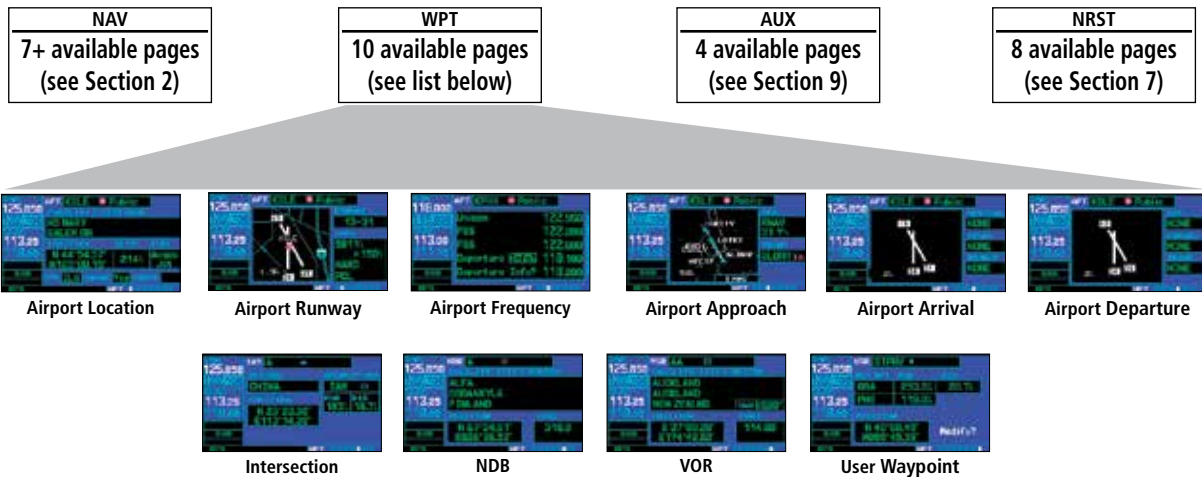

NOTE: Please note that your 400W-series uses ICAO identifiers for all airports. All U.S. airport identifiers which contain only letters use the prefix "K". For example, Los Angeles International is KLAX under the ICAO standard. Other airports, such as Otten Memorial (3VS), that contain numbers in the identifier, do not require the "K" prefix. Many foreign countries use two letter prefixes.

6 - WPT PAGES

Identifier, Facility, Location or City

The WPT page group includes ten pages. While viewing any WPT page, turn the **small right** knob to select a different WPT page. The first six pages provide detailed information for the selected airport: location, runways, frequencies, approaches, arrivals, and departures. The last four pages provide information for intersections, NDBs, VORs and user-created waypoints.

After a WPT page is selected, information for a waypoint may be viewed by entering the identifier (or name) of the desired waypoint. Airports, NDBs and VORs may be selected by identifier, facility name or location (city).

To enter a waypoint identifier:

1. Select the desired WPT page and press the **small right** knob to activate the cursor.
2. Turn the **small right** knob to select the first character of the waypoint's identifier.
3. Turn the **large right** knob to select the next character field.
4. Turn the **small right** knob to select the desired character.
5. Repeat steps 3 and 4 until the identifier is selected, then press **ENT**.
6. To remove the flashing cursor, press the **small right** knob.

To enter a waypoint facility name or city location:

1. Select the airport location page, NDB page or VOR page from the WPT page group.
2. Press the **small right** knob to activate the cursor.
3. Turn the **large right** knob to select the facility name or location (city) field.
4. Turn the **small right** knob to select the desired character.

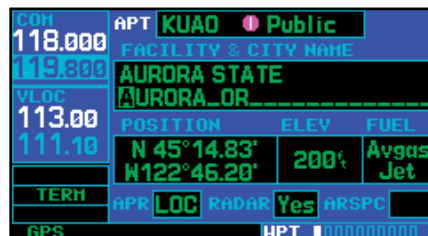

5. Turn the **large right** knob to select the next character field.
6. Repeat steps 4 and 5 until the facility name or location is selected, then press **ENT**.

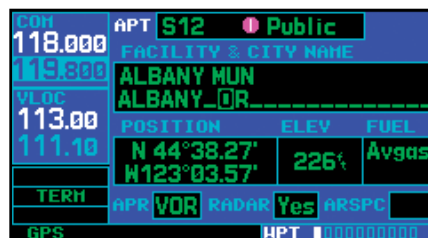

7. To remove the flashing cursor, press the **small right** knob.

Duplicate Waypoints

Once the identifier, facility name or location is entered, all six airport pages will display information for the selected airport. As you enter an identifier, facility name or location, the 400W-series Spell'N'Find™ feature will scroll through the database, displaying those waypoints matching the characters you have entered to that point. If duplicate entries exist for the entered facility name or location, additional entries may be viewed by continuing to turn the **small right** knob during the selection process. If duplicate entries exist for an entered identifier, a *duplicate waypoint page* will appear once you select the identifier (by pressing **ENT**).

To select a facility name or location, where duplicate entries exist:

1. Select the desired facility name or location.
2. As you spell the facility name or location, using the **small** and **large right** knobs, the 400W-series Spell'N'Find feature will select the first entry in the database based upon the characters you have entered up to that point.

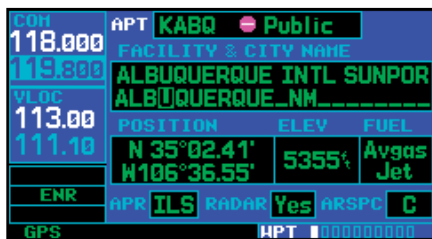

3. Continue turning the **small right** knob to scroll through any additional database listings for the selected facility name or location. You can scroll backwards with the **small right** knob if you scroll past the desired facility name or location.

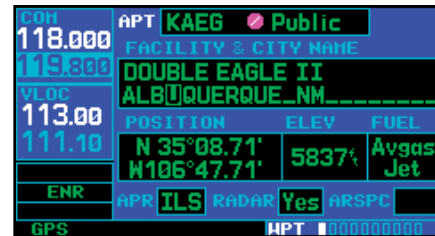

4. Press **ENT** to select the desired facility name or location.
5. To remove the flashing cursor, press the **small right** knob.

To select a waypoint identifier from a list of duplicates:

1. Select the desired airport or navaid identifier.
2. A duplicate waypoints window will appear. Turn the **large right** knob to select the desired waypoint and press **ENT**.

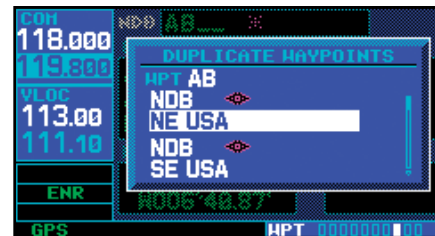

3. To remove the flashing cursor, press the **small right** knob.

Airport Location Page

The *airport location page* displays the latitude, longitude, and elevation of the selected airport. The *airport location page* also displays facility name and location, as well as fuel availability, available approaches, radar coverage and airspace type.

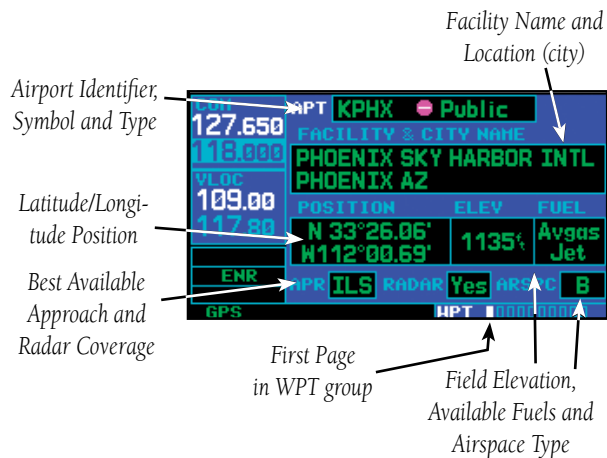

The following descriptions and abbreviations are used:

- **Type**— Usage type: Public, Military, Heliport, or Private
- **Position**— Latitude/Longitude (degrees/minutes or degrees/minutes/seconds), MGRS or UTM/UPS
- **Elevation**— In feet or meters
- **Fuel**— For public-use airports, the available fuel type(s) are: Avgas (80-87/100LL/100-130/Mogas), Jet, or None
- **Approach**— Best available approach: ILS, MLS, LOC, LDA, SDF, GPS, VOR, RNAV (“RNV”), LORAN (“LOR”), NDB, TACAN (“TCN”), Helicopter

(“HEL”), or VFR

- **Radar**— Radar coverage: Yes or No
- **Airspace**— Control environment: CTA, TMA, TRSA, Class B, Class C, Class D, or none

Airport Location Page Options**Select Next FPL Apt?**

Selecting the Next Airport page menu option allows you to display the next waypoint in the flight plan and activates it for editing.

To select the next FPL airport from the Airport Location Page:

1. Press **MENU** to display the Airport Location Page Options.
2. Turn the **small** or **large right** knob to highlight “Select Next FPL Apt?” and then press **ENT**.

Select Destination Apt?

Selecting the Destination Airport page menu option allows you to display the Destination waypoint in the flight plan.

To select the Destination airport from the Airport Approach Page:

1. Press **MENU** to display the Airport Approach Page Options.
2. Turn the **small** or **large right** knob to highlight “Select Destination Apt?” and then press **ENT**.

Airport Runway Page

The *airport runway page* displays runway designations, length, surface type and lighting for the selected airport. A map image of the runway layout and surrounding area is also displayed on the *airport runway page*. The map image scale appears in the lower left corner and is adjustable using the **RNG** key. For airports with multiple runways, information for each runway is available.

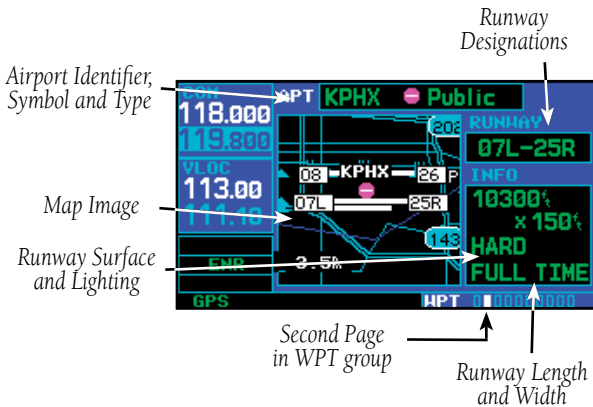

To display information for each additional runway:

1. Press the **small right** knob to activate the cursor.
2. Turn the **large right** knob to place the cursor on the runway designation field.

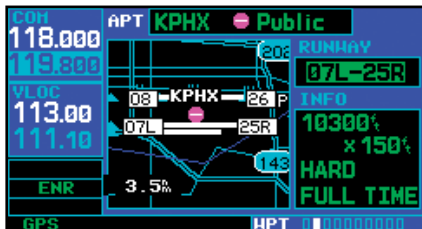

3. Turn the **small right** knob to display a window listing all runways for the selected airport.

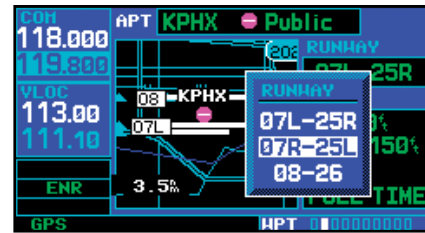

4. Continue turning the **small right** knob to select the desired runway.
5. Press **ENT** to display information for the selected runway on the airport runway page.



6. To remove the flashing cursor, press the **small right** knob.

To adjust the scale of the map image:

1. Press the down arrow side of the **RNG** key to display a smaller map area.
2. Press the up arrow side of the **RNG** key to display a larger map area.

6 - WPT PAGES

Airport Frequencies

The following descriptions and abbreviations are used on the airport runway page:

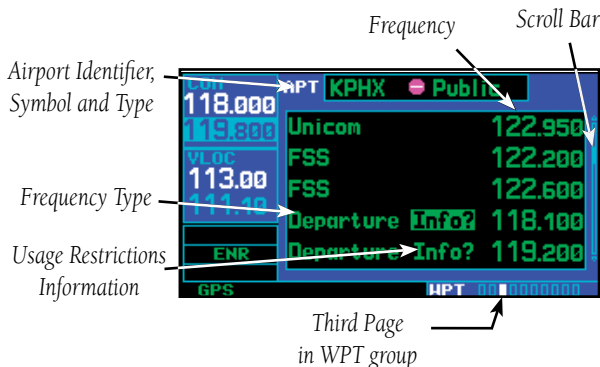

- **Type**— Usage type: Public, Military, Helicopter, or Private
- **Surface**— Runway surface types include: Hard, Turf, Sealed, Gravel, Dirt, Soft, Unknown or Water
- **Lighting**— Runway lighting types include: No Lights, Part Time, Full Time, Unknown or Frequency (for pilot-controlled lighting)

Airport Runway Page Options

Select Next FPL Apt?

As described earlier in this section.

Select Destination Apt?

As described earlier in this section.

Airport Frequency Page

The *airport frequency page* displays radio frequencies and frequency types for the selected airport, as well as sector and altitude restrictions (where applicable). If the selected airport has a localizer-based approach, the localizer frequency(s) is also listed on the *airport frequency page*. The *airport frequency page* may be used to quickly select and tune a COM or VLOC frequency.

To scroll through the frequency list and tune to a desired frequency on the list:

1. Press the **small right** knob to activate the cursor.
2. Turn the **large right** knob to scroll through the list, placing the cursor on the desired frequency. If there are more frequencies in the list than can be displayed on the screen, a scroll bar along the right-hand side of the screen will indicate where you are within the list.



3. Press **ENT** to place the selected frequency in the standby field of the COM or VLOC window.



- To remove the flashing cursor, press the **small right** knob.

Some listed frequencies may include designations for limited usage, as follows:

- “TX” - transmit only
- “RX” - receive only
- “PT” - part time frequency

If a listed frequency has sector or altitude restrictions, the frequency will be preceded by an “Info?” designation.

To view usage restrictions for a frequency:

- Turn the **large right** knob to place the cursor on the “Info?” designation directly to the left of the desired frequency. A reversed “c” is placed to the left of CTAF frequencies.

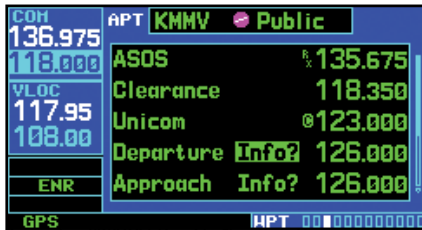

- Press **ENT** to display the restriction information.



- To return to the airport frequency page, press **ENT**.

The following descriptions and abbreviations are used on the airport frequency page:

- Usage type: Public, Military, Heliport, or Private
- Frequency— Communication frequencies which may include restrictions:

| | | |
|----------|----------|-----------|
| Approach | Arrival | Class B |
| Class C | CTA | Departure |
| TMA | Terminal | TRSA |

Communication frequencies without restrictions:

| | | |
|----------|-----------|------------|
| ATIS | ASOS | AWOS |
| Center | Clearance | Gate |
| Control | Ground | Helicopter |
| Multicom | Pre-taxi | Radar |
| Ramp | Other | Tower |
| | Unicom | |

Navigation frequencies:

| | |
|-----|-----|
| ILS | LOC |
|-----|-----|

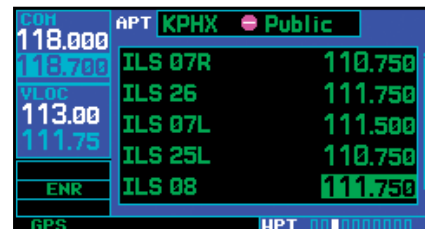
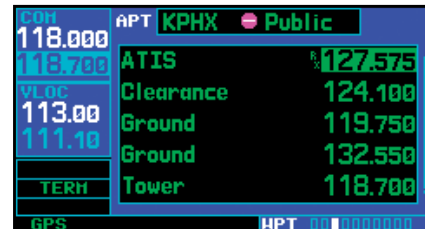

Airport Frequency Page Options

Select Next FPL Apt?

As described earlier in this section.

Select Destination Apt?

As described earlier in this section.

Airport Approach Page

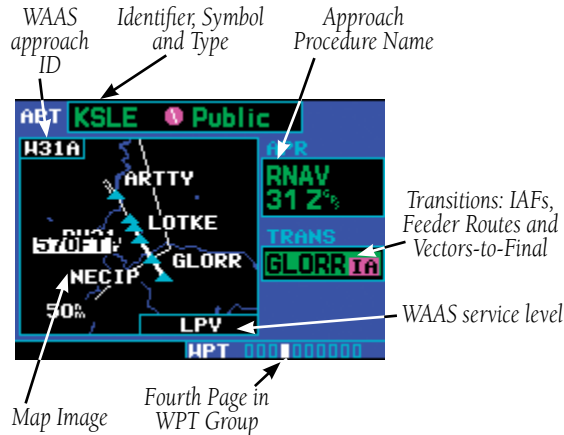

The *airport approach page* shows the available approach procedures for the selected airport. Where multiple initial approach fixes (IAFs) and feeder routes are available, that information may also be displayed. A map image provides a layout diagram for each approach and transition.

If a WAAS approach has been selected, the WAAS approach ID is displayed in the top left corner of the map. The approach service level is shown in the lower right corner of the map. Service level annunciations available are: LP, LPV, LP +V, L/VNAV, LNAV+V, or LNAV.

To scroll through the available approaches and transitions:

1. Press the **small right** knob to activate the cursor.

2. Turn the **large right** knob to place the cursor on the approach (APR) procedure name field.



3. Turn the **small right** knob to display a window of available approaches for the selected airport. Continue turning the **small right** knob to select the desired approach.



4. Press **ENT**. The cursor moves to the transitions (TRANS) field.
5. Turn the **small right** knob to display a window of available transitions. Continue turning the **small right** knob to select the desired transition or select "VECTORS" for guidance only along the final course segment of the approach.



6. Press **ENT**. To remove the flashing cursor, press the **small right** knob.



NOTE: Not all approaches in the database are approved for GPS use. As you select an approach, a “G_P” designation to the right of the procedure name indicates the procedure can be flown using the GPS receiver. Some procedures will not have this designation, meaning the GPS receiver may be used for supplemental navigation guidance only. ILS approaches, for example, must be flown by tuning the VLOC receiver to the proper frequency and coupling the VLOC receiver to the external CDI (or HSI).

Airport Approach Page Options

The following options are available for the airport approach page, by pressing the **MENU** key:

Load into Active FPL? allows you to load the selected approach into the active flight plan—with-out activating it. This performs the same operation as selecting “Load?” from the procedures page “Select Approach?” option.

To load an approach from the airport approach page:

1. Select the desired approach and transition using the steps outlined in Section 5.



2. Press **MENU** to display the airport approach page options.
3. Turn the **large right** knob to highlight “Load into Active FPL?” and press **ENT**.

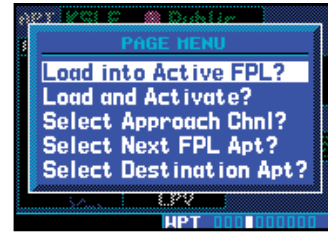

4. The active flight plan page will appear. Press **FPL** to return to the airport procedures page.

Load and Activate? allows you to load the selected approach into the active flight plan and activate navigation guidance to the approach transition.

To load and activate an approach from the airport approach page, follow the steps above, but select “Load and Activate?” in step #3.

Select Approach Chnl? allows you to select the channel number for a WAAS approach for the current destination. The channel number for the WAAS approach is available from an approved approach chart.

If duplicate numbers are available for a channel, a list will be available where you may select the desired approach.



After selecting “Select Approach Chnl?”, choose the WAAS channel number for the current destination.

After selecting the Approach Channel, the WAAS approach ID will be shown in the top left corner of the map display.

To select an approach channel from the Airport Approach Page:

1. Press **MENU** to display the Airport Approach Page Options.
2. Turn the **small** or **large right** knob to highlight "Select Approach Chnl?" and then press **ENT**.
3. Turn the **small right** knob to change values and the **large right** knob to move the cursor. After selecting the WAAS approach channel, press **ENT**.
4. Select the desired transition and press **ENT**.

Select Next FPL Apt?

As described earlier in this section.

Select Destination Apt?

As described earlier in this section.

Airport Arrival Page

The airport arrival page shows the available Airport Standard Terminal Arrival (STAR) procedures for the selected airport. Where multiple transitions or runways are associated with the arrival procedure, that information may also be displayed. A map image provides a layout diagram for each arrival, transition and runway.

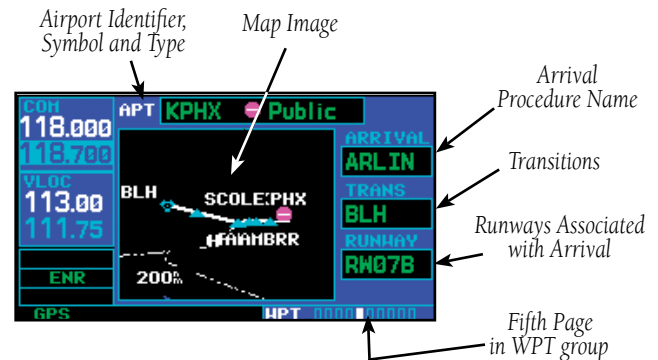

To scroll through the available arrivals:

1. Press the **small right** knob to activate the cursor.
2. Turn the **large right** knob to place the cursor on the arrival procedure name field.

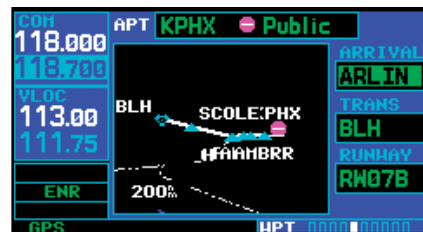

3. Turn the **small right** knob to display a window of available arrivals for the selected airport. Continue turning the **small right** knob to select the desired arrival.



- Press **ENT**. The cursor moves to the transitions (TRANS) field.
- Turn the **small right** knob to display a window of available transitions. Continue turning the **small right** knob to select the desired transition.



- Press **ENT**. The cursor moves to the runway field.
- Turn the **small right** knob to display a window of available runways. Continue turning the **small right** knob to select the desired runway. ("ALL" may appear in the runway field, indicating the arrival procedure applies to all runways. For airports with parallel runways, "B" may appear at the end of the runway designation to indicate the arrival procedure applies to both runways.)



- Press **ENT**. To remove the flashing cursor, press the **small right** knob.

Airport Arrival Page Options

The following options are available for the *airport arrival page*, by pressing the **MENU** key:

Load into Active FPL?

As described earlier in this section.

Select Next FPL Apt?

As described earlier in this section.

Select Destination Apt?

As described earlier in this section.

Airport Departure Page

The *airport departure page* shows the available Airport Standard Instrument Departure (SID) procedures for the selected airport. Where multiple runways or transitions are associated with the departure procedure, that information may also be displayed. A map image provides a layout diagram for each departure, runway and transition.

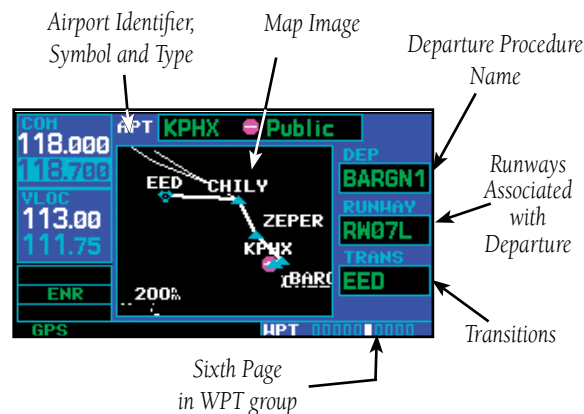

To scroll through the available departures:

- Press the **small right** knob to activate the cursor.

6 - WPT PAGES

Airport Departure Page

- Turn the **large right** knob to place the cursor on the departure (DEP) procedure name field.



- Turn the **small right** knob to display a window of available departures for the selected airport. Continue turning the **small right** knob to select the desired departure.



- Press **ENT**. The cursor moves to the runway field.
- Turn the **small right** knob to display a window of available runways. Continue turning the **small right** knob to select the desired runway. ("ALL" may appear in the runway field, indicating the departure procedure applies to all runways. For airports with parallel runways, "B" may appear at the end of the runway designation to indicate the departure procedure applies to both runways.)



- Press **ENT**. The cursor moves to the transitions (TRANS) field.
- Turn the **small right** knob to display a window of available transitions. Continue turning the **small right** knob to select the desired transition.
- Press **ENT**. To remove the flashing cursor, press the **small right** knob.

Airport Departure Page Options

The following options are available for the *airport departure page*, by pressing the **MENU** key:



Load into Active FPL?

As described earlier in this section.

Select Next FPL Apt?

As described earlier in this section.

Select Destination Apt?

As described earlier in this section.

Intersection Page

The *intersection page* displays the latitude, longitude, region and country for the selected intersection. The *intersection page* also displays the identifier, radial and distance from the nearest VOR, VORTAC or VOR/DME. Intersections may only be selected by identifier. There are no Intersection page options.

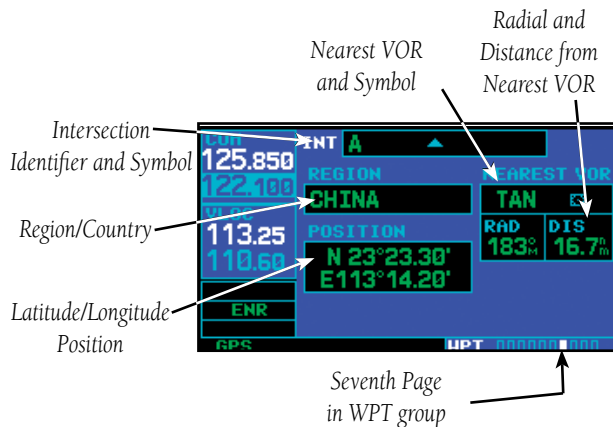

The following descriptions and abbreviations are used:

- Position— Latitude/Longitude (degrees/minutes or degrees/minutes/seconds), MGRS or UTM/UPS
- RAD— Radial from nearest VOR in degrees magnetic or degrees true (depending upon unit configuration)
- DIS— Distance from nearest VOR, in nautical miles/statute miles/kilometers (depending upon unit configuration)



NOTE: The VOR displayed on the intersection page is the nearest VOR, not necessarily the VOR used to define the intersection.

NDB Page

The *NDB page* displays the facility name, city, region/country, latitude and longitude for the selected NDB. The *NDB page* also displays the frequency and a weather broadcast indication (if applicable). NDBs may be selected by identifier, facility name or location (city). There are no NDB page options.

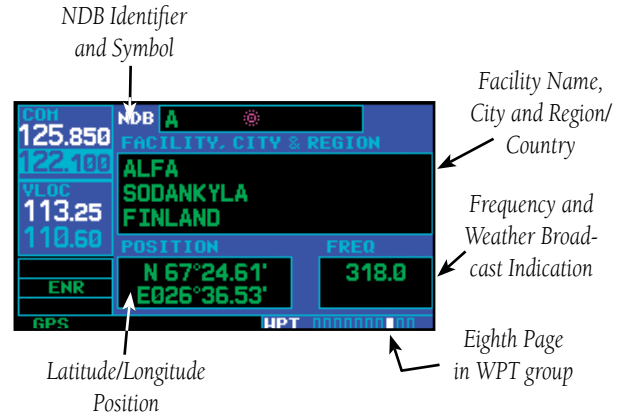

The following descriptions and abbreviations are used:

- Symbol— See Section 2 Nav Pages - Map Page for a graphic illustration of available NDB symbols
- Position— Latitude/Longitude (degrees/minutes or degrees/minutes/seconds), MGRS or UTM/UPS
- FREQ— Frequency in kilohertz (kHz)
- Wx Brdcst— Weather information is broadcast on the selected facility's frequency

VOR Page

The *VOR page* displays the facility name, city, region/country, magnetic variation, latitude and longitude for the selected VOR. The *VOR page* also displays the frequency and a weather broadcast indication (if applicable). There are no VOR page options.

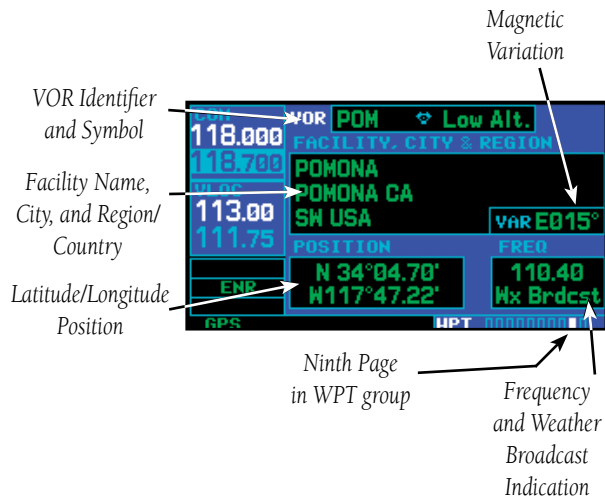

The following descriptions and abbreviations are used:

- Symbol— See Section 2 Nav Pages - Map Page for a graphic illustration of available VOR symbols
- VAR— Magnetic variation in degrees
- Position— Latitude/Longitude (degrees/minutes or degrees/minutes/seconds), MGRS or UTM/UPS
- FREQ— Frequency in megahertz (MHz)
- Wx Brdcst— Weather information is broadcast on the selected facility's frequency

As mentioned in the beginning of Section 6, VORs may be selected by identifier, facility name or location (city). The *VOR page* may also be used to quickly tune the VLOC receiver to the selected VOR's frequency.

To select a VOR frequency from the VOR page:

1. Select the VOR page from the WPT page group.
2. Press the **small right** knob momentarily to place the cursor on the VOR identifier field. If you wish to select another VOR, use the **small** and **large right** knobs and press **ENT** when finished.

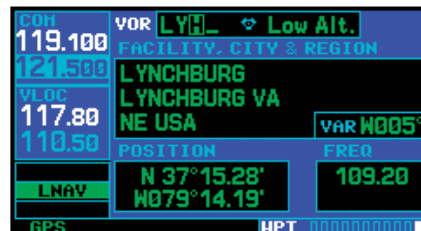

3. Turn the **large right** knob to highlight the frequency field and press **ENT** to place the frequency in the standby field of the VLOC window.

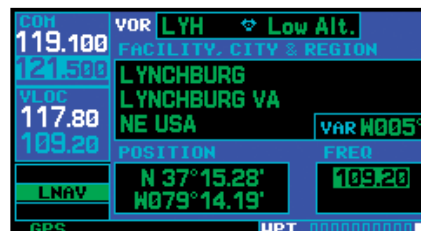

4. To activate the standby VLOC frequency, press the **VLOC flip-flop** key.

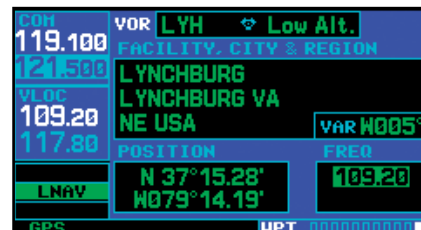

User Waypoint Page

In addition to the airport, VOR, NDB and intersection information contained in your Jeppesen NavData® card, the 400W-series units allow you to store up to 1,000 user-defined waypoints. The user waypoint page displays the waypoint name (up to five characters long), identifier and radial from two reference waypoints, distance from one reference waypoint, along with the user waypoint's latitude/longitude position.

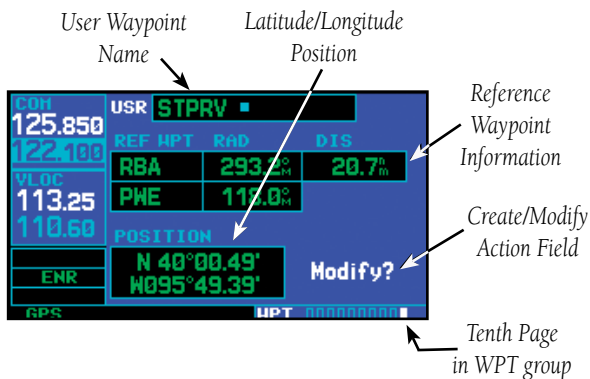

The following descriptions and abbreviations appear on the *user waypoint page*:

- REF WPT— Reference waypoint identifier (name)
- RAD— Radial from reference waypoint, in degrees magnetic or degrees true (depending upon unit configuration)
- DIS— Distance from reference waypoint, in nautical miles/statute miles/kilometers (depending upon unit configuration)
- Position— Latitude/Longitude (degrees/minutes or degrees/minutes/seconds), MGRS or UTM/UPS

User waypoints may only be selected by name (identifier), as described in the beginning of Section 6.

Creating User Waypoints

User waypoints may be created from the *user waypoint page* or the *map page*. To create a new user waypoint, simply enter its name (identifier) and position, or reference another waypoint by radial and distance.

To create a new user waypoint by entering its latitude/longitude position:

1. With the user waypoint page displayed, press the **small right** knob to activate the cursor.
2. Use the **small** and **large right** knobs to enter a name for the new waypoint and press **ENT**. Your present position appears in the position field at the bottom of the page. To create a waypoint at your present position, turn the **large right** knob to highlight "Create?" and skip to step #6.



3. Turn the **large right** knob to highlight the position field at the bottom of the page.
4. Use the **small** and **large right** knobs to enter the position coordinates for the new waypoint.

6 - WPT PAGES

Creating User Waypoints

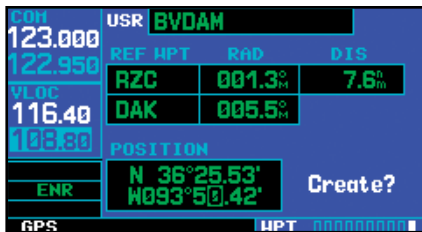

5. Press **ENT** to accept the selected position.
6. The cursor moves to "Create?". Press **ENT** to add the new waypoint to memory.
7. Press the **small right** knob to remove the flashing cursor.

To create a new user waypoint by referencing an existing waypoint:

1. With the user waypoint page displayed, press the **small right** knob to activate the cursor.
2. Use the **small** and **large right** knobs to enter a name for the new waypoint and press **ENT**.
3. Turn the **large right** knob to highlight the first reference waypoint (REF WPT) field.
4. Use the **small** and **large right** knobs to enter the identifier of the reference waypoint. The reference waypoint can be an airport, VOR, NDB, intersection or another user waypoint. Press **ENT** to accept the selected identifier.
5. The cursor moves to the radial (RAD) field. Use the **small** and **large right** knobs to enter the radial from the reference waypoint to the new user waypoint. Press **ENT** to accept the selected radial.



6. The cursor moves to the distance (DIS) field. Use the **small** and **large right** knobs to enter the distance from the reference waypoint to the new user waypoint. Press **ENT** to accept the selected distance.
7. Turn the **large right** knob to highlight "Create?" and press **ENT**.



8. Press the **small right** knob to remove the flashing cursor.



NOTE: The 400W-series units allow you to create a new user waypoint at a defined radial and distance from your present position. To reference your present position, follow the steps above, but press **CLR** in step #4. "P.POS" will appear in the reference waypoint (REF WPT) field to indicate that radial and distance information will reference your present position.

The second reference waypoint field (REF WPT) is a temporary reference only—not a reference that will be stored with the user waypoint. By default, this field will display a radial from the nearest VOR. However, you can select any waypoint—by identifier—to use as a reference in this field.

Your 400W-series unit can store user-defined

waypoints which are generated from other equipment in your panel. For example, an EFIS equipped with joystick inputs can be used to create user waypoints which will (if your installation supports this) automatically transfer to your 400W-series unit.

Creating User Waypoints from the Map Page

The map page and panning target pointer provide a quick means of saving your present position as a user-defined waypoint.

To capture and save your present position as a user waypoint:

1. With the map page displayed, press the **small right** knob to activate the panning function. The target pointer will appear at your present position.



2. Press **ENT** to capture the position and display the user waypoint page.



3. A four-digit name is automatically assigned to the waypoint. To change this name, turn the **large right** knob to highlight the name field, then use the **small** and **large right** knobs to select a new name. Press **ENT** to accept the selected name.

4. The cursor moves to the "Create?" action field. Press **ENT** to save the new waypoint.

Modifying User Waypoints

To modify an existing waypoint, select that waypoint on the user waypoint page and enter the new position information directly over the old information.

To modify a user waypoint by changing its latitude/longitude position:

1. With the user waypoint page displayed, press the **small right** knob to activate the cursor.
2. Use the **small** and **large right** knobs to enter the name of the desired waypoint and press **ENT**.
3. Turn the **large right** knob to highlight the position field at the bottom of the page.
4. Use the **small** and **large right** knobs to enter the new position coordinates and press **ENT** to accept the selected position.



5. The cursor moves to the "Modify?" action field. Press **ENT** to modify the waypoint.
6. Press the **small right** knob to remove the flashing cursor.

To modify a user waypoint by changing reference waypoint information:

1. With the user waypoint page displayed, press the **small right** knob to activate the cursor.
2. Use the **small** and **large right** knobs to enter the name of the desired waypoint and press **ENT**.

6 - WPT PAGES

Modifying User Waypoints

- Turn the **large right** knob to highlight the first reference waypoint (REF WPT) field, if you wish to change the reference waypoint. Otherwise, continue turning the **large right** knob to highlight the radial (RAD) or distance (DIS) field, as desired.
- Use the **small** and **large right** knobs to change the identifier — if desired — of the reference waypoint. The reference waypoint can be an airport, VOR, NDB, intersection or another user waypoint. Press **ENT** to accept the selected identifier.



- The cursor moves to the radial (RAD) field. Use the **small** and **large right** knobs to change the radial from the reference waypoint, if desired. Press **ENT** to accept the selected radial.



- The cursor moves to the distance (DIS) field. Use the **small** and **large right** knobs to change the distance from the reference waypoint to the new user waypoint, if desired. Press **ENT** to accept the selected distance.



- The cursor moves to the "Modify?" action field. Press **ENT** to modify the waypoint.
- Press the **small right** knob to remove the flashing cursor.



NOTE: If you attempt to modify or delete a waypoint which is currently a direct-to waypoint or the current "from" or "to" waypoint in the active flight plan, the 400W-series unit will alert you with the "Can't change an active waypoint" or "Waypoint is active and can't be deleted" message. You must first cancel the direct-to or remove the waypoint(s) from the active flight plan before modifying or deleting the waypoint(s).

User Waypoint Page Options

The following *user waypoint page* options are available by pressing the **MENU** key:

View User Waypoint List? displays a list of all user waypoints currently stored in memory.

To view a list of all user waypoints:

- From the user waypoint page, press **MENU** to display the user waypoint page options.
- Turn the **large right** knob to highlight "View User Waypoint List?" and press **ENT**.

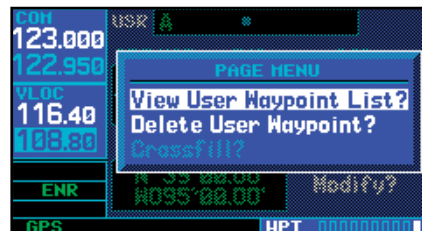

- The top of the user waypoint list will indicate the total number of user waypoints currently used and available memory. If more user waypoints are stored than can be displayed on a single screen, turn the **large right** knob to scroll through the user waypoint list.



- Press the **small right** knob to return to the user waypoint page.

Delete User Waypoint? allows you to delete the selected waypoint from memory.

To delete a user waypoint:

- Select the desired waypoint on the user waypoint page and press **MENU** to display the user waypoint page options.
- Turn the **large right** knob to highlight “Delete User Waypoint?” and press **ENT**.



Crossfill? allows you to transfer a user waypoint to another 400W/500W series unit (if installed).

User Waypoint List

The user waypoint list allows you to review, modify, rename or delete a selected user waypoint, or to delete all user waypoints currently stored in memory. The top of the page shows the number of waypoints used and available memory.



To review and/or modify a user waypoint from the user waypoint list:

- Select the user waypoint list, as described in the User Waypoint Options.
- Turn the **large right** knob to highlight the desired user waypoint.
- Press **ENT** to display the user waypoint page for the selected waypoint. From this page you may review all information defining the waypoint and its position.
- To modify the waypoint’s position or reference waypoint information, follow the steps described “Modifying User Waypoints.” (Keep in mind that you’ve already selected a user waypoint page which displays the desired user waypoint, so you may skip the first two steps of the procedure.)
- To exit the user waypoint page, turn the **large right** knob to highlight “Done?” and press **ENT**.

6 - WPT PAGES

User Waypoint Page Options

To rename a user waypoint from the user waypoint list:

1. Select the user waypoint list.
2. Turn the **large right** knob to highlight the desired user waypoint.
3. Use the **small** and **large right** knobs to change the name of the user waypoint. (Enter the new name directly over the old name.) Press **ENT** to accept the new name.



4. A "rename waypoint" confirmation window is displayed. With "Yes?" highlighted, press **ENT** to rename the selected user waypoint.

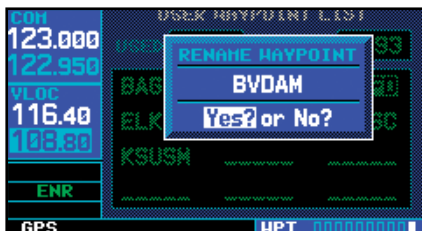

To delete a user waypoint from the user waypoint list:

1. Select the user waypoint list.
2. Turn the **large right** knob to highlight the desired user waypoint.
3. Press **CLR** to display a "delete waypoint" confirmation window.

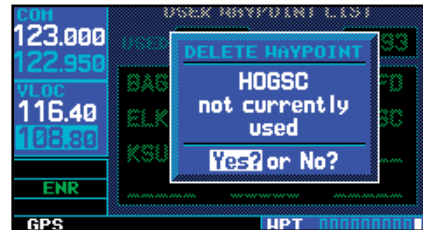

4. With "Yes?" highlighted, press **ENT** to delete the selected user waypoint.

To delete all user waypoints from memory:

1. Select the user waypoint list.
2. Press **MENU** to display an options window for the user waypoint list.
3. With "Delete All User Waypoints" highlighted, press **ENT**.
4. A "delete all waypoints" confirmation window is displayed. With "Yes?" highlighted, press **ENT** to delete all user waypoints from memory.

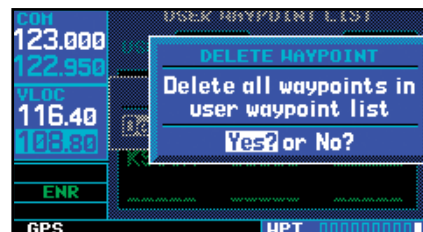

Section 7

NRST Pages

NRST Page Group

Section 2 introduced the 400W-series main page groups—NAV, WPT, AUX, NRST—and described each page in the NAV group. This fourth page group (NRST) provides detailed information for the 25 nearest airports, VORs, NDBs, intersections and user waypoints within 200 NM of your current position. In addition, the NRST pages include the five nearest Flight Service Station (FSS) and center (ARTCC/FIR) points of communication, plus alerts you to any Special Use (SUA) or Controlled Airspace you may be in or near.

To quickly select a NRST page:

1. In the GPS 400W and GNC 420W, press the **NRST** key. From any page in the GNS 430W, press and hold **CLR** to select the default NAV page. (You may skip this step if you are already viewing any of the main pages. See Section 2)
2. Turn the **large right** knob to select the NRST page group. "NRST" will appear in the lower right corner of the screen.



3. Turn the **small right** knob to select the desired NRST page.

| NAV |
|---------------------------------------|
| 7+ available pages (see Section 2) |

| WPT |
|---------------------------------------|
| 10 available pages (see Section 6) |

| AUX |
|--------------------------------------|
| 4 available pages (see Section 9) |

| NRST |
|---------------------------------------|
| 8 available pages (see list below) |



Nearest Airport



Nearest Intersection



Nearest NDB



Nearest VOR



Nearest User



Nearest Center

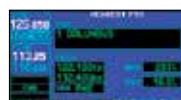

Nearest Flight Service



Nearest Airspace

Not all 25 nearest airports, VORs, NDBs, intersections or user waypoints can be displayed on the corresponding NRST page at one time. The *nearest airport page* displays detailed information for three nearest airports, with a scroll bar along the right-hand side of the page indicating which part of the list is currently being viewed. The *nearest airspace page* displays detailed information for up to three special use or controlled airspace alerts. The NRST pages for VORs, NDBs, intersections, and user waypoints will display five waypoints at a time. The flashing cursor and **large right** knob are used to scroll and view the rest of the waypoints or airspaces in the list.

To scroll through the list of nearest airports, VORs, NDBs, intersections, user waypoints or SUAs:

1. Select the desired NRST page.
2. Press the **small right** knob to activate the cursor.
3. Turn the **large right** knob to scroll through the list. The scroll bar along the right-hand side of the page will indicate which part of the list is currently being viewed.



4. Press the **small right** knob to remove the flashing cursor.

The nearest ARTCC and nearest FSS pages present detailed information for up to five nearby facilities—displaying only one facility at a time. Again, the additional information is viewed using the flashing cursor and **small right** knob to scroll through the list.

To scroll through the list of nearest flight service station or center points of communication:

1. Select the desired NRST page.
2. Press the **small right** knob to activate the cursor.
3. Turn the **small right** knob to scroll through the list.

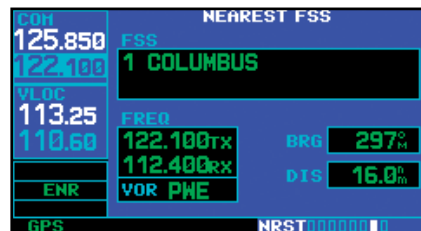

4. Press the **small right** knob to remove the flashing cursor.

Navigating to a Nearby Waypoint

The NRST pages can be used in conjunction with the direct-to function to quickly set a course to a nearby facility. This feature can be a real time saver compared to retrieving information from the database using the WPT pages. More importantly, it instantly provides navigation to the nearest airport in case of an in-flight emergency.

To select a nearby airport, VOR, NDB, intersection or user waypoint as a direct-to destination:

1. Use the flashing cursor to scroll through a NRST page list and highlight the desired nearest waypoint.

| COM | NEAREST VOR | | | |
|---------|-------------|------|-------------------|--------|
| | VOR | BRG | DIS | FREQ |
| 125.850 | PWE | 298° | 17.1 ^m | 112.40 |
| 122.100 | RBA | 115° | 24.7 ^m | 108.20 |
| VLOC | BIE | 287° | 42.5 ^m | 110.60 |
| 113.25 | STJ | 093° | 44.8 ^m | 115.50 |
| 110.60 | TOP | 160° | 57.0 ^m | 117.80 |
| ENR | | | | |
| GPS | | | | |

2. Press **direct-to** to display the select direct-to waypoint page.

| COM | SELECT → WAYPOINT | |
|---------|-------------------|--------------|
| 123.000 | PDK | NE USA |
| 122.950 | FREDERICK | FREDERICK MD |
| VLOC | | |
| 116.40 | FPL | KFDK |
| 108.80 | | |
| ENR | N 39°24.73' | CRS 197° |
| GPS | W077°22.51' | Activate? |
| | DRCT | |

3. Press **ENT** to accept the selected waypoint's identifier and press **ENT** a second time (with "Activate?" highlighted) to begin navigating to the selected waypoint.

| COM | SELECT → WAYPOINT | |
|---------|-------------------|------------|
| 119.100 | PDK | SE USA |
| 121.900 | PEACHTREE | ATLANTA GA |
| VLOC | | |
| 109.90 | FPL | KATL |
| 116.90 | | |
| ENR | N 33°52.54' | CRS 026° |
| GPS | W084°17.93' | Activate? |
| | HSG | DRCT |

Nearest Airport Page

The *nearest airport page* displays the identifier, symbol, bearing and distance to the 25 nearest airports (within 200 NM of your present position). For each airport listed, the *nearest airport page* also indicates the best available approach, common traffic advisory frequency (CTAF) and the length of the longest runway.

| COM | NEAREST AIRPORT | | | |
|---------|-----------------|---------|-------------------|-----|
| | APT | BRG | DIS | APP |
| 127.650 | 5VA0 | 163° | 35.8 ^m | GPS |
| 125.175 | | | rwly 0% | |
| VLOC | 478 | 159° | 37.6 ^m | GPS |
| 109.20 | uni | 122.800 | rwly 4011' | |
| 115.60 | KFVX | 089° | 38.7 ^m | GPS |
| ENR | uni | 122.800 | rwly 4400' | |
| GPS | | | | |

Best Available Approach
Scroll Bar
Airport Identifier, Symbol, Bearing To and Distance To
Tower or CTAF Frequency and Longest Runway
First Page in NRST group

The *nearest airport page* can be configured to exclude shorter runways or undesirable runway surface types, so that the corresponding airports do not appear on the list. You may wish to use this feature to exclude seaplane bases or runway lengths which would be difficult or impossible to land upon. See Sec 9 - Nearest Airport Criteria for additional details.

The *nearest airport page* may be used to quickly tune the COM transceiver to a nearby airport. The selected frequency is placed in the standby field of the COM window and activated using the **COM flip-flop** key.

7 - NRST PAGES

Nearest Airports

To quickly tune the common traffic advisory frequency (CTAF) from the nearest airport page:

1. Select the nearest airport page.
2. Press the **small right** knob to activate the cursor.
3. Turn the **large right** knob to scroll through the list, highlighting the COM frequency associated with the desired airport.



4. Press **ENT** to place the selected frequency in the standby field of the COM window.



5. Press the **COM flip-flop** key to activate the selected frequency.



6. Press the **small right** knob to remove the flashing cursor.

Additional communication frequencies, runway information and more is available from the *nearest airport page* by highlighting the identifier of the desired airport and pressing **ENT**.

To view additional information for a nearby airport:

1. Select the nearest airport page.
2. Press the **small right** knob to activate the cursor.
3. Turn the **large right** knob to scroll through the list, highlighting the identifier of the desired airport.



4. Press **ENT** to display the airport location page for the selected airport.

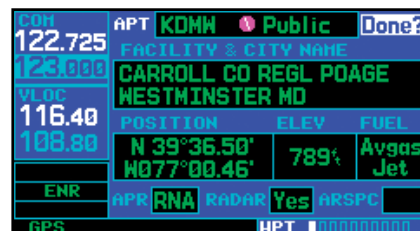

5. To view additional WPT pages for the selected airport (including the airport runway and airport frequency pages) press the small right knob to remove the flashing cursor. Turn the **small right** knob to display the additional WPT pages. When finished, press the **small right** knob to return the flashing cursor to the screen.

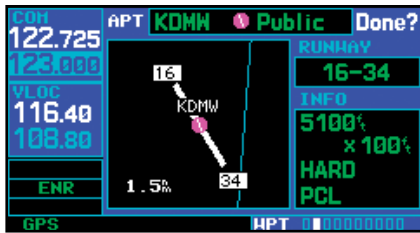

- To return to the nearest airport page, verify that "Done?" is highlighted by the flashing cursor and press **ENT** (or press **CLR**).

Nearest Intersection Page

The *nearest intersection page* displays the identifier, symbol, bearing and distance to the 25 nearest intersections (within 200 NM of your present position).

To view additional information for a nearby intersection, start from the nearest intersection page and follow steps 2 through 4 above.

Nearest NDB Page

The *nearest NDB page* displays the identifier, symbol, bearing, distance and frequency to the 25 nearest NDBs (within 200 NM of your present position).

To view additional information for a nearby NDB, start from the nearest NDB page and follow steps 2 through 4 above.

Nearest VOR Page

The nearest VOR page displays the identifier, symbol, bearing and distance to the 25 nearest VORs (within 200 NM of your present position). For each VOR listed, the nearest VOR page also indicates the frequency and may be used to quickly tune the VLOC receiver to the nearby VOR. The selected frequency is placed in the standby field of the VLOC window and activated using the **VLOC flip-flop** key.

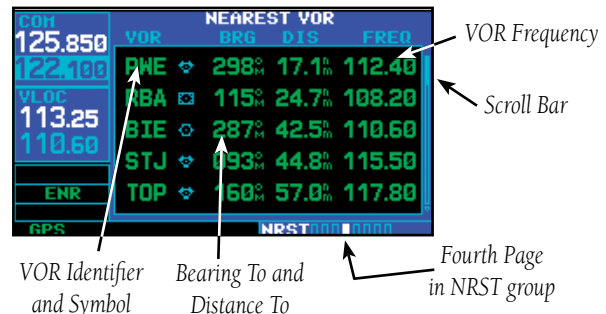

To quickly tune a VOR's frequency from the nearest VOR page:

- Select the nearest VOR page.
- Press the **small right** knob to activate the cursor.
- Turn the **large right** knob to scroll through the list, highlighting the frequency associated with the desired VOR.

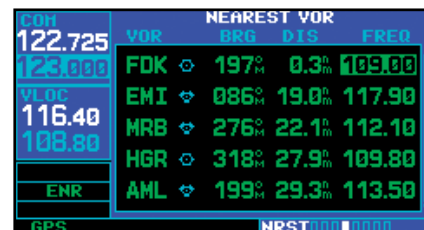

- Press **ENT** to place the selected frequency in the standby field of the VLOC window.

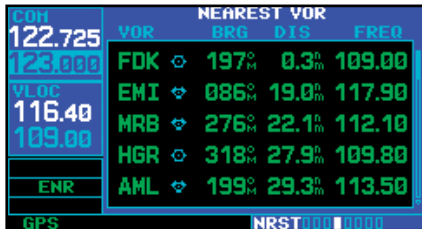

- Press the **VLOC flip-flop** key to activate the selected frequency.
- Press the **small right** knob to remove the flashing cursor.

To view additional information for a nearby VOR:

- Select the nearest VOR page.
- Press the **small right** knob to activate the cursor.
- Turn the **large right** knob to scroll through the list, highlighting the identifier of the desired VOR.
- Press **ENT** to display the VOR page for the selected VOR.



- To return to the nearest VOR page, verify that "Done?" is highlighted by the flashing cursor and press **ENT** (or press **CLR**).
- Press the **small right** knob to remove the flashing cursor.

Nearest User Waypoint Page

The *nearest user waypoint page* displays the name, bearing and distance to the 25 nearest user waypoints (within 200 NM of your present position).

Nearest Center (ARTCC) Page

The *nearest center page* displays the facility name, bearing to and distance to the five nearest ARTCC points of communication (within 200 NM of your present position). For each ARTCC listed, the *nearest center page* also indicates the frequency(s) and may be used to quickly tune the COM transceiver to the center's frequency. The selected frequency is placed in the standby field of the COM window and activated using the **COM flip-flop** key.

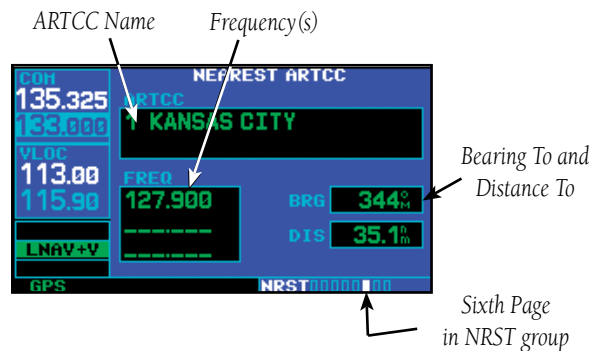

To quickly tune an ARTCC's frequency from the nearest center page:

1. Select the nearest center page.
2. Press the **small right** knob to activate the cursor.
3. Turn the **small right** knob to scroll through the list, selecting the desired ARTCC.



4. Turn the **large right** knob to scroll down the page, highlighting the desired frequency.



5. Press **ENT** to place the selected frequency in the standby field of the COM window.



6. Press the **COM flip-flop** key to activate the selected frequency.
7. Press the **small right** knob to remove the flashing cursor.

Nearest Flight Service Station (FSS) Page

The nearest flight service station page displays the facility name, bearing to and distance to the five nearest FSS points of communication (within 200 NM of your present position). For each FSS listed, the nearest flight service station page also indicates the frequency(s) and may be used to quickly tune the COM transceiver to the FSS's frequency. The selected frequency is placed in the standby field of the COM window and activated using the **COM flip-flop** key.

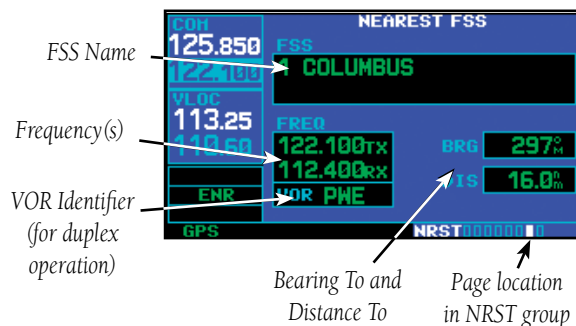

For duplex operations, “RX” and “TX” indications will appear beside the listed frequencies—indicating “receive only” or “transmit only” frequencies. The associated VOR is also provided for reference.

To quickly tune an FSS's frequency from the nearest flight service station page:

1. Select the nearest flight service station page and press the **small right** knob to activate the cursor.
2. Turn the **small right** knob to scroll through the list, selecting the desired FSS.



3. Turn the **large right** knob to scroll down the page, highlighting the desired frequency (COM frequency[s] or VOR frequency for duplex operation).



4. Press **ENT** to place the selected frequency in the standby field of the COM or VLOC window.



5. Press the **COM flip-flop** or **VLOC flip-flop** key, as appropriate, to activate the selected frequency.
6. Press the **small right** knob to remove the flashing cursor.

Nearest Airspace Page

The last page in the NRST group, the *nearest airspace page*, will alert you to as many as nine controlled or special use airspaces near or in your flight path. Alerts are provided according to the following conditions:

- If your projected course will take you inside an airspace within the next ten minutes, the alert message “**Airspace ahead -- less than 10 minutes**” will appear. The *nearest airspace page* will show the airspace as “**Ahead**”.



- If you are within two nautical miles of an airspace and your current course will take you inside, the message “**Airspace near and ahead**” will appear. The *nearest airspace page* will show “**Within 2nm of airspace**”.
- If you are within two nautical miles of an airspace and your current course will **not** take you inside, the message “**Near airspace less than 2nm**” will appear. The *nearest airspace page* will show the airspace as “**Ahead < 2nm**”.
- If you have entered an airspace, the message “**Inside Airspace**” will appear. The *nearest airspace page* will show “**Inside of airspace**”.



Note that the airspace alerts are based on three-dimensional data (latitude, longitude and altitude) to avoid nuisance alerts. The alert boundaries for controlled airspace are also sectorized to provide complete information on any nearby airspace. Once one of the described conditions exists, the message annunciator will flash, alerting you of an airspace message.

To view an airspace alert message:

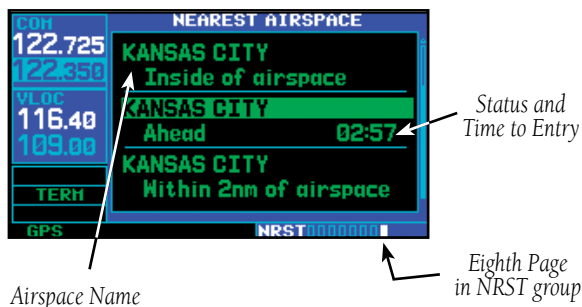

1. When the message annunciator above the **MSG** key flashes, press **MSG**.
2. Press **MSG** again to return to the previous page.

Once you have been provided an airspace alert message, detailed information concerning the specific airspace is provided on the *nearest airspace page*. The *nearest airspace page* displays the airspace name, status (“Ahead”, “Ahead < 2nm”, etc. as described on the previous page), and a time to entry (if applicable). By selecting any airspace name listed on the *nearest air-*

space page, additional details will be provided—including controlling agency, communication frequencies and floor/ceiling limits.

To view additional details for an airspace listed on the nearest airspace page:

1. Select the nearest airspace page.

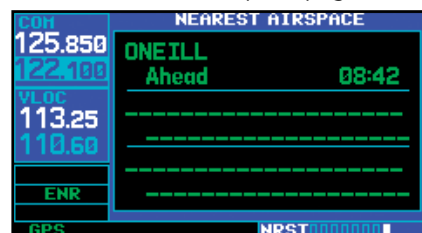

2. Press the **small right** knob to activate the cursor.
3. Turn the **large right** knob to scroll through the list, highlighting the desired airspace.

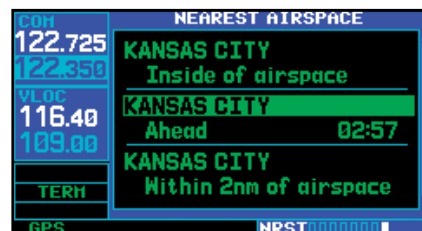

4. Press **ENT** to display the airspace page for the selected nearby airspace.

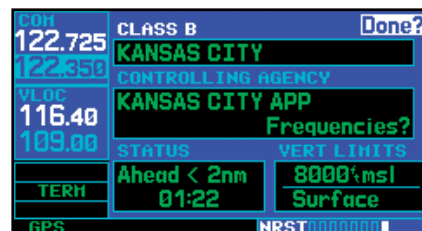

5. To return to the nearest airspace page, verify that “Done?” is highlighted by the flashing cursor and press **ENT**.

7 - NRST PAGES

Nearest Airspaces

- Press the **small right** knob to remove the flashing cursor.

To view and quickly tune the frequency for a controlling agency:

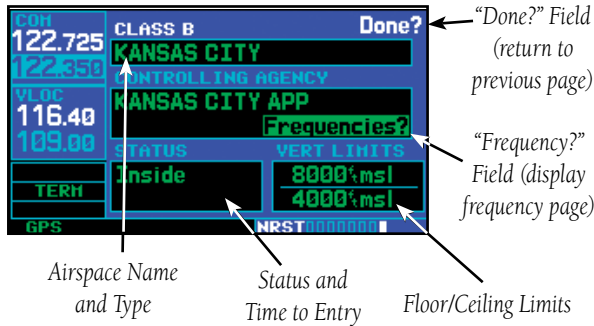

- Follow steps #1 through #4 on the previous page to display the airspace page for the desired controlled or special use airspace.
- Turn the **large right** knob to highlight “Frequencies?” and press **ENT**.

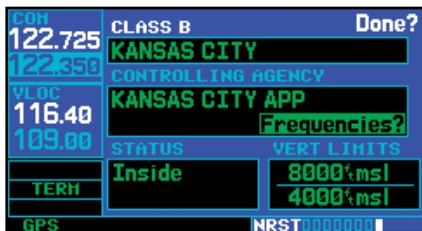

- Turn the **large right** knob to scroll through the list, highlighting the desired frequency.



- Press **ENT** to place the selected frequency in the standby field of the COM window.

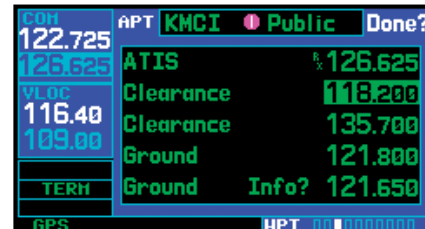

- Press the **COM flip-flop** key to activate the selected frequency.
- To return to the airspace page, turn the **large right** knob to highlight “Done?” and press **ENT** (or press **CLR**).
- To return to the nearest airspace page, turn the **large right** knob to highlight “Done?” and press **ENT** (or press **CLR**).
- Press the **small right** knob to remove the flashing cursor.

The *airspace page* displays (and airspace alert messages are provided for) the following airspace types:

- Alert
- Caution
- Class B
- Class C
- Class D
- CTA
- Danger
- MOA
- Prohibited
- Restricted
- TMA
- Training
- TRSA
- Unspecified
- Warning

The bottom right-hand corner of the *airspace page* displays the floor and ceiling limits of the airspace. The following are examples of what may appear as vertical limits for an airspace:

- 5000 ft msl (5000 feet mean sea level)
- 5000 ft agl (5000 feet above ground level)
- MSL (at mean sea level)
- NOTAM (see Notice to Airmen) *
- Unknown * • Unlimited *
- See Chart * • Surface *

* Not shown in this example

All airspace alert messages, except for prohibited areas, may be turned on or off from the *airspace alarms* page. An altitude buffer is also provided on the *airspace alarms* page to provide an extra margin of safety above/below the published limits.

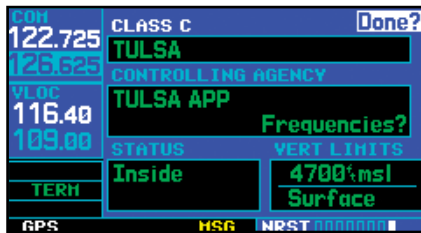

Blank Page

Section 8 VLOC (VOR/Localizer/Glideslope) Receiver Operations

The GNS 430W includes digitally-tuned VOR/localizer and glideslope receivers with the desired frequency selected on a *VLOC window*, along the left-hand side of the display. Frequency selection is performed by pressing the **small left** knob and turning the **small** and **large left** knobs to select the desired frequency.



Ident Audio and Volume

VLOC ident is enabled by pressing the **VLOC volume** knob. When VLOC ident is enabled, an “ID” indication appears in the upper right corner of the VLOC window — to the immediate right of “VLOC”.



Push for ident audio. Turn to adjust audio volume.

VLOC audio volume is adjusted using the **VLOC volume** knob. Turn the **VLOC volume** knob clockwise to increase volume, or counterclockwise to decrease volume.

VLOC Window and Tuning

VLOC frequencies are selected with the tuning cursor in the *standby* VLOC frequency field, and using the **small** and **large left** knobs to dial in the desired frequency. The standby frequency always appears below the *active* frequency. The active frequency is the frequency currently in use.



Push to toggle the tuning cursor (small left knob) between COM and VLOC windows. Turn to adjust the kHz value (the portion after the decimal point) of standby VLOC frequency.



Turn to adjust the MHz value (the portion before the decimal point) of the standby VLOC frequency.

The tuning cursor will remain in the COM window. If you wish to select a VOR/localizer/ILS frequency, press the **small left** knob momentarily to place the cursor in the VLOC window.



NOTE: *The tuning cursor will normally appear in the COM window, unless placed in the VLOC window by pressing the **small left** knob. When the tuning cursor is in the VLOC window, it will automatically return to the COM window after 30 seconds of inactivity.*

To select a VOR/localizer/ILS frequency:

1. If the tuning cursor is not currently in the VLOC window, press the **small left** knob momentarily.



2. Turn the **large left** knob to select the desired megahertz (MHz) value. For example, the "117" portion of the frequency "117.80".

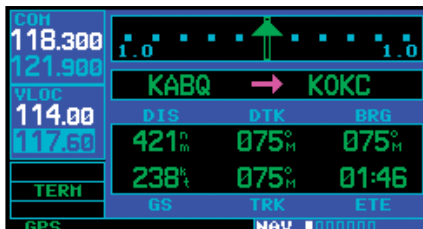

3. Turn the **small left** knob to select the desired kilohertz (kHz) value. For example, the ".80" portion of the frequency "117.80".

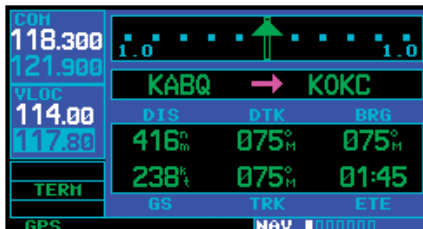

4. To make the standby frequency the active frequency, press the **VLOC flip-flop** key.

Auto-Tuning

A frequency may also be quickly selected from the database by simply highlighting the desired frequency on the *VOR page* or the *nearest VOR page* and pressing the **ENT** key. This process is referred to as *auto-tuning*. Once a frequency is selected in the standby field, it may be transferred to the active frequency by pressing the **VLOC flip-flop** key. (Auto-tuning can also be performed from VLOC frequencies listed on the *NAVCOM*, *airport frequency*, and *nearest flight service station* pages.)

To select a VLOC frequency from the VOR or nearest VOR pages:

1. Select the desired page from the main pages. (See page references on the preceding page.)
2. Press the **small right** knob momentarily to activate the flashing cursor.
3. Turn the **large right** knob to highlight the frequency for the desired VOR.

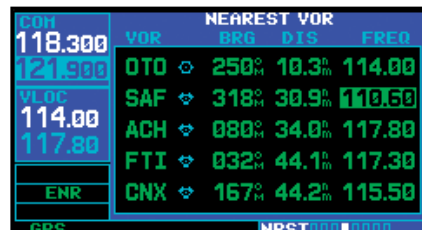

4. Press **ENT** to place the frequency in the standby field of the VLOC window.

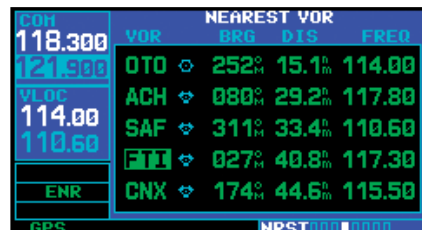

5. Press the **VLOC flip-flop** key to activate the selected frequency.

- Press the **small right** knob to remove the flashing cursor.



NOTE: For duplex COM operations, the VLOC receiver may be auto-tuned from the nearest flight service station page.

When selecting a VOR or ILS approach, manual tuning of the VLOC receiver is not required. Once the approach procedure is “Loaded” or “Activated”, the GNS 430W will automatically place the proper frequency in the standby field of the VLOC window. If you wish to use this frequency, simply press the **VLOC flip-flop** key to activate the frequency. Additional information on approach procedures is provided in Section 5.

To select an approach and automatically tune the proper VLOC frequency:

- Select the destination airport using the **direct-to** key or as the last waypoint in the active flight plan.
- Press the **PROC** key to display the procedures page.
- Turn the **large right** knob to highlight “Select Approach?” and press **ENT**.

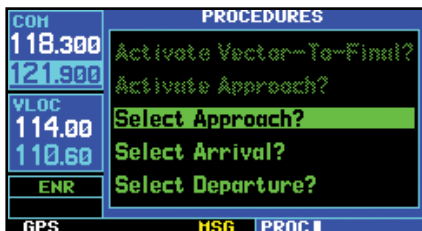

- A window will appear listing the available procedures. Turn the **small right** knob to highlight the desired procedure and press **ENT**. (When a direct-to destination is selected, departures are offered for the nearest airport.)

- A second window will appear listing available transitions. Turn the **small right** knob to highlight the desired transition waypoint and press **ENT**. (The approach “Vectors” option assumes you will receive vectors to the final course segment of the approach and will provide navigation guidance to intercept this final course.)
- Turn the **large right** knob to highlight “Load?” or “Activate?” and press **ENT**. (“Load?” will add the procedure to the flight plan without immediately using it for navigation guidance. This allows you to continue navigating the original flight plan, but keeps the procedure available on the active flight plan page for quick activation when needed.)

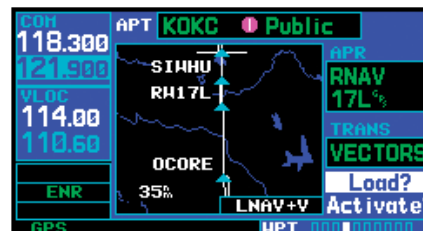

- For VOR and ILS approaches, the standby field of the VLOC window is automatically tuned to the proper frequency. To activate the frequency press the **VLOC flip-flop** key. To display VLOC course information on the external CDI (or HSI) press **CDI** and verify that “VLOC” is displayed at the bottom left corner of the screen, directly above the **CDI** key.

8 - VLOC RECEIVER

Auto-tuning / CDI Key

GNS 430W Only

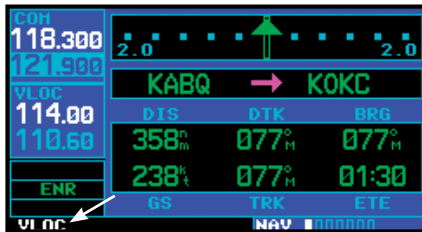
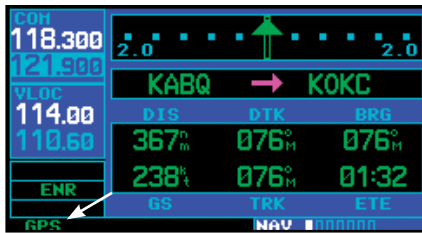

- For precision approaches and some non-precision approaches, a reminder window will appear indicating that GPS guidance on such approaches is strictly for monitoring only—use the VLOC receivers and external CDI (or HSI) for primary navigation. To confirm this reminder, highlight “Yes?” and press **ENT**.

CDI Key

The GNS 430W's **CDI** key is used to couple the GPS or VLOC receiver to the external CDI (or HSI). When the external CDI (or HSI) is being driven by the GPS receiver, “GPS” will appear at the bottom left corner of the page, directly above the **CDI** key. When the external CDI (or HSI) is being driven by the VLOC receiver, “VLOC” will appear instead.

To couple the external CDI (or HSI) to the GPS receiver or VLOC receiver, press the CDI key to display “GPS” or “VLOC”, as desired.



NOTE: The external CDI (or HSI) must be coupled to the VLOC receiver for approaches which are not approved for GPS. See the ILS example in the Procedures section.



NOTE: GPS level of service annunciations (LPV, ENR, etc. as shown on page 83) are not applicable to the external CDI (or HSI) when VLOC is active.

Section 9 AUX Pages

AUX Page Group

Section 2 introduced the 400W-series main page groups—NAV, WPT, AUX, NRST—and described each page in the NAV group. The third page group (AUX) allows you to change unit settings, customizing operation to your preferences. The AUX pages also provide E6B functions—such as trip planning, fuel planning, density altitude, true airspeed and winds aloft calculations.

To quickly select an AUX page:

- From any page, press and hold **CLR** to select the default NAV page. (You may skip this step if you are already viewing any of the main pages.)

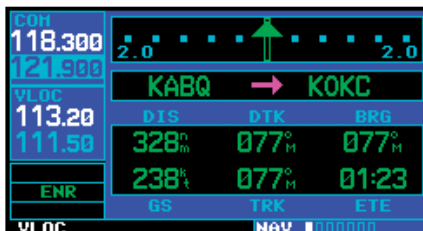

- Turn the **large right** knob to select the AUX page group. "AUX" will appear in the lower right corner of the screen.



- Turn the **small right** knob to select the desired AUX page.

NAV
7 available pages
(see Section 2)

WPT
10 available pages
(see Section 6)

AUX
4 available pages
(see list below)

NRST
8 available pages
(see Section 7)



Flight Planning

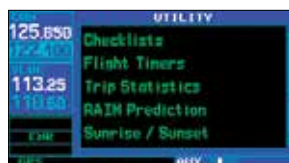

Utility

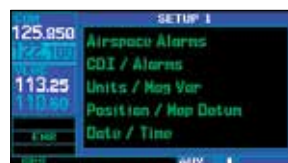

Setup 1



Setup 2

Flight Planning Page

The *flight planning page* provides access to E6B functions for fuel planning, trip planning, density altitude/true airspeed/winds aloft calculations and a “Crossfill” function to transfer flight plans/user waypoints to a second 400W-series unit. When a flight planning item is selected, the corresponding page will appear providing additional information and features.

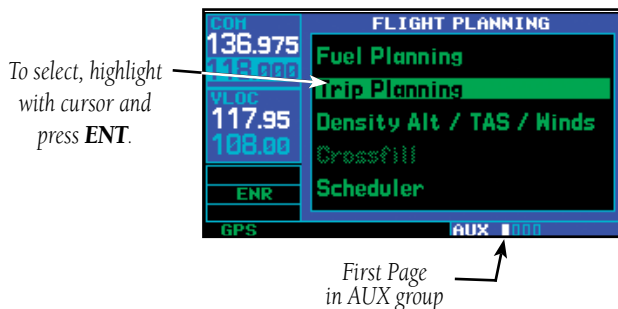
**To select an item from the flight planning page:**

1. Press the **small right** knob momentarily, to activate the flashing cursor.



2. Turn the **large right** knob to select the desired menu option, and press **ENT**.

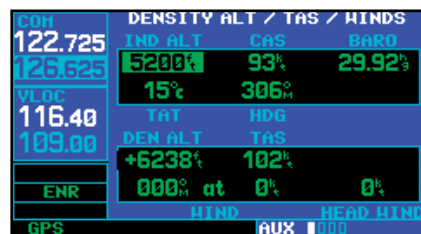
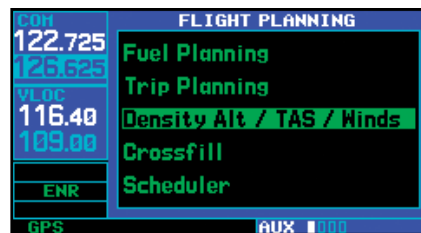

The following flight planning items are available:

Fuel Planning— when equipped with fuel flow (FF) and/or fuel on board (FOB) sensors, this item displays current fuel conditions along the active direct-to or flight plan. You may also manually enter fuel flow, ground speed (GS) and (in some instances) fuel on board figures for planning purposes. Fuel planning figures can be displayed not only for the currently active flight plan or direct-to, but also point-to-point between two specified waypoints and for any programmed flight plan.

Trip Planning— allows the pilot to view desired track (DTK), distance (DIS), estimated time en route (ETE), en route safe altitude (ESA) and estimated time of arrival (ETA) information for a direct-to, point-to-point between two specified waypoints or for any programmed flight plan.



NOTE: Point-to-point waypoints, flight plans and/or ground speed (default is current GPS-calculated ground speed) entered on the fuel planning page will automatically transfer to the trip planning page, and vice versa.

Density Alt / TAS / Winds— indicates the theoretical altitude at which your aircraft will perform depending upon several environmental conditions, including indicated altitude (IND ALT), barometric setting (BARO) and total air temperature (TAT; the temperature, including the heating effect of speed, read on a standard outside temperature gauge). This computes true airspeed (TAS), based upon the factors above and the calibrated airspeed (CAS). Also, this determines winds aloft—the wind direction and speed—and a head wind/tail wind component, based upon the calculated density altitude (DEN ALT), true airspeed, aircraft heading (HDG) and ground speed.

Crossfill— allows the pilot to transfer the active flight plan, including VNAV parameters any stored flight plan, a user waypoint or all user waypoints between two 400W-Series Garmin units in a dual-unit installation.

Scheduler— displays reminder messages (such as “Change oil”, “Switch fuel tanks”, “Overhaul”, etc.). One-time, periodic, and event-based messages are allowed. One-time messages will appear once the timer expires and will reappear each time the 400W-series unit is powered on, until the message is deleted. Periodic messages will automatically reset to the original timer value, once the message is displayed. Event-based messages do not use a timer, but rather a specific date and time.



NOTE: *Crossfill and Manual GTN Crossfill can not be configured to be present at the same time. The chosen feature is configured by the installer for your installation.*

Manual GTN Crossfill — The Manual GTN Crossfill Function allows the GNS 400W/500W series unit to manually send all User waypoints to the connected GTN unit or receive information from a GTN unit.

Fuel Planning

To perform fuel planning operations:

1. Select “Fuel Planning” from the flight planning page.
2. The current fuel planning “mode” is displayed at the top of the page: “POINT TO POINT” or “FPL” (for a flight plan). To change the mode, press **MENU** to display an options window for the other mode, then press **ENT** to accept the other mode.

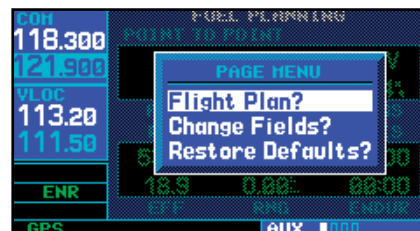
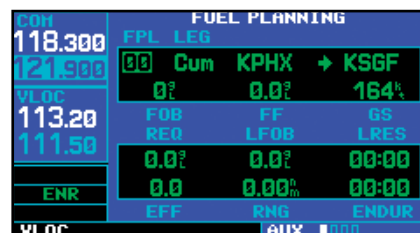

The “Flight Plan?” option allows you to select the numbered flight plan for fuel planning. The “Change Fields?” option allows you to select fuel information for each field as desired.

- 3a. For point-to-point fuel planning, turn the **small** and **large right** knobs to enter the identifier of the “from” waypoint. Once the waypoint’s identifier is entered, press **ENT** to accept the waypoint. The flashing cursor moves to the “to” waypoint. Again, turn the **small** and **large right** knobs to enter the identifier of the “to” waypoint and press **ENT** to accept the waypoint.

| FUEL PLANNING | | | |
|----------------|------------|--------------------------------|-------|
| POINT TO POINT | | | |
| COH | 779 → KGNV | | |
| 118.300 | 93% | 11.5% | 174% |
| VLOC | FOB | FLOH | GS |
| 113.20 | REQ | LFOB | LRES |
| 111.50 | 56.4% | 36.4% | 03:10 |
| ENR | 15.1 | 1404 ⁿ _m | 08:04 |
| GPS | EFF | RNG | ENDUR |
| | | | AUX |

OR

- 3b. For flight plan fuel planning, turn the **small right** knob to select the desired flight plan by number (already stored in memory. "00" is the active flight plan). Turn the **large right** knob to highlight the "LEG" field and turn the **small right** knob to select the desired leg of the flight plan, or select "Cum" to apply fuel planning calculations to the entire flight plan.

| FUEL PLANNING | | | |
|---------------|--------------------|-------|-------|
| FPL LEG | | | |
| COH | 00 Cum KOJC → KSJC | | |
| 118.300 | 1200% | 30.0% | 340% |
| VLOC | FOB | FLOH | GS |
| 113.20 | REQ | LFOB | LRES |
| 111.50 | 115.4% | 1084% | 36:08 |
| ENR | 11.3 | --- | 39:59 |
| GPS | EFF | RNG | ENDUR |
| | | | AUX |

4. If your fuel management system does not enter the data automatically, turn the **large right** knob to highlight the fuel on board (FOB) field.

| FUEL PLANNING | | | |
|---------------|--------------------|-------|-------|
| FPL LEG | | | |
| COH | 00 Cum KOJC → KSJC | | |
| 118.300 | 1199% | 30.0% | 340% |
| VLOC | FOB | FLOH | GS |
| 113.20 | REQ | LFOB | LRES |
| 111.50 | 115.4% | 1083% | 36:07 |
| ENR | 11.3 | --- | 39:57 |
| GPS | EFF | RNG | ENDUR |
| | | | AUX |

5. Use the **small** and **large right** knobs to enter the amount of fuel on board. Press **ENT** when finished.

6. The flashing cursor moves to the fuel flow (FF) field. Use the **small** and **large right** knobs to enter the fuel flow rate. Press **ENT** when finished. Note that if a fuel system is providing current fuel flow, the fuel flow field will default to this value.
7. The flashing cursor moves to the ground speed (GS) field. Use the **small** and **large right** knobs to enter the ground speed. Press **ENT** when finished.
8. With all variables entered, the following information will be provided:
- REQ — Quantity of fuel required
 - LFOB — Left-over fuel on board
 - LRES — Left-over fuel reserve time
 - EFF — Efficiency, expressed in distance per fuel units (e.g. nautical miles per gallon)
 - RNG — Range (distance)
 - ENDUR — Flight endurance, or total available flight time

| FUEL PLANNING | | | |
|----------------|---------|--------------------------------|-------|
| POINT TO POINT | | | |
| COH | P.POS → | | |
| 118.300 | 0% | 0.0% | 0% |
| VLOC | FOB | FLOH | GS |
| 113.20 | REQ | LFOB | LRES |
| 111.50 | 0.0% | 0.0% | 00:00 |
| ENR | 0.0 | 0.00 ⁿ _m | 00:00 |
| GPS | EFF | RNG | ENDUR |
| | | | AUX |

9. To reconfigure the data fields press **MENU** to display the options window. Turn the **small right** knob to highlight the "change fields?" option. Press **ENT** to reconfigure the data fields. Turn the **large right** knob to select the desired field. Turn the **small right** knob to

highlight the desired data. Press **ENT** to select the data configuration.

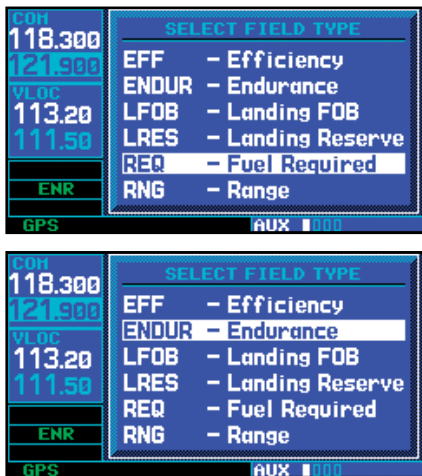

NOTE: Fuel planning figures can be entered and displayed based upon one of three possible configurations:

1) No fuel sensors connected—In this instance fuel flow is manually entered and is used to calculate fuel on board. When fuel flow or fuel on board is manually entered, the figures are retained the next time you view the page (with fuel on board continuously recalculated).

2) Fuel flow sensor installed, but no fuel on board sensor—Fuel on board is manually entered. Fuel flow is automatically provided by sensor. If fuel flow is manually entered (to override the sensor), it will not affect the FOB figure and is not retained the next time you view the page.

3) Fuel flow and fuel on board sensors installed—Fuel flow and fuel on board are automatically provided by sensors. Fuel on board can NOT be entered manually. Fuel flow can be entered manually, but will not affect the FOB figure and is not retained the next time you view the page.

Trip Planning

To perform trip planning operations:

1. Select "Trip Planning" from the flight planning page.
2. The current trip planning "leg mode" is displayed at the top of the page: "POINT TO POINT" or "FPL LEG" (for a flight plan leg). To change the leg mode, press **MENU** to display an options window for the other leg mode, then press **ENT** to accept the other leg mode.
- 3a. For point-to-point trip planning, turn the **small** and **large right** knobs to enter the identifier of the "from" waypoint. Once the waypoint's identifier is entered, press **ENT** to accept the waypoint. The flashing cursor moves to the "to" waypoint. Again, turn the **small** and **large right** knobs to enter the identifier of the "to" waypoint and press **ENT** to accept the waypoint.



OR,

- 3b. For "flight plan leg" trip planning, turn the **small right** knob to select the desired flight plan (already stored in memory), by number. Turn the **large right** knob to highlight the "LEG" field and turn the **small right** knob to select the desired leg of the flight plan, or select "Cum" to apply trip planning calculations to the entire flight plan.

9 - AUX PAGES

Flight Planning



- Turn the **large right** knob to highlight the departure time (DEP TIME) field.
- Use the **small** and **large right** knobs to enter the departure time. Press **ENT** when finished. (Departure time may be entered in local or UTC time, depending upon unit settings.)
- The flashing cursor moves to the ground speed (GS) field. Use the **small** and **large right** knobs to enter the ground speed. Press **ENT** when finished.
- With all variables entered, the following information will be provided:
 - DTK— Desired track, or desired course
 - DIS— Distance
 - ETE— Estimated time en route
 - ESA— En route safe altitude
 - ETA— Estimated time of arrival



Density Alt / TAS / Winds

To calculate density altitude, true airspeed, winds aloft:

- Select “Density Alt / TAS / Winds” from the flight planning page.



- The flashing cursor highlights the indicated altitude (IND ALT) field. Use the **small** and **large right** knobs to enter the altitude indicated on your altimeter. Press **ENT** when finished.
- The flashing cursor moves to the calibrated airspeed (CAS) field. Use the **small** and **large right** knobs to enter the airspeed from your airspeed indicator. Press **ENT** when finished.

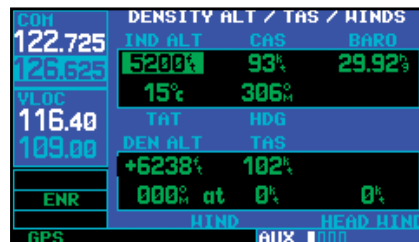

- The flashing cursor moves to the barometric setting (BARO) field. Use the **small** and **large right** knobs to enter the barometric setting (altimeter setting). Press **ENT** when finished.
- The flashing cursor moves to the total air temperature (TAT) field. Use the **small** and **large right** knobs to enter the temperature. Press **ENT** when finished.

6. The flashing cursor moves to the aircraft heading (HDG) field. Use the **small** and **large right** knobs to enter the aircraft heading from the directional gyro or compass. Press **ENT** when finished.
7. With all variables entered, the following information will be provided:
 - DEN ALT— Density altitude
 - TAS— True airspeed
 - WIND— Wind direction and speed
 - HEAD/TAIL WIND— Magnitude of head wind or tail wind component

| CON | DENSITY ALT / TAS / WINDS | | |
|---------|---------------------------|-----------|-----------|
| 118.300 | IND ALT | CAS | BARO |
| 121.500 | 5200' | 93% | 29.92" |
| W. DC | 15% | 300% | |
| 113.20 | TAT | HDG | |
| 111.50 | DEN ALT | TAS | |
| | +6238' | 102% | |
| ENR | 000% at | 0% | 0% |
| GPS | WIND | HEAD WIND | TAIL WIND |
| | AUX | 000 | |



NOTE: If your installation includes components (such as an airdata sensor) to provide any of the variables above, the density alt/tas/winds page data will default to the values provided by these components.

Crossfill Operation

The Crossfill Function allows the pilot to transfer a direct-to destination, the active flight plan including VNAV parameters, any stored flight plan, a user waypoint, or all user waypoints between two 400W-Series (or 500W-Series) Garmin units in a dual-unit installation. There is only one Crossfill function page. It may be accessed pressing the **MENU** key and selecting Crossfill while viewing the default Nav page, Flight Plan Catalog, Active Flight Plan, User Waypoint page, or the Aux mode Flight Planning page and then pressing **ENT**.



NOTE: The databases of the 400/500 series and the 400W/500W are incompatible, so you may not mix systems.

To select Crossfill

Select “Crossfill?” from the Default NAV Page, Flight Plan Catalog page, Active Flight Plan page, or the User Waypoint page by pressing **MENU**, scrolling down to “Crossfill” with the **large right** knob and then pressing **ENT**. On the Aux Flight Planning page scroll down to “Crossfill” with the **large right** knob, and then press **ENT**.



- **Automatic Operation:** If both units are set to automatic, a change in the active flight plan or VNAV parameters of one unit will also be seen in the other. Initiating a direct-to to a waypoint on one unit will also initiate a direct-to to the same waypoint on the other unit. If one unit is set for automatic crossfill and the other is set for manual crossfill, then only the auto unit will automatically send data to the manual unit. In this configuration, the auto unit could be thought of as the master unit.
- **Manual Operation:** If manual operation is desired, the pilot must invoke all transfers from that unit. When a unit is configured for automatic transfer, a manual transfer can also be done on command. If either of the messages “data transfer error” or “data transfer cancelled” are received during an automatic or

manual transfer, the pilot must force another transfer.

To transfer flight plans or user waypoints to/from a second 400W (or 500W) Series unit:

1. While viewing the default Nav page, Flight Plan Catalog, Active Flight Plan page, User Waypoint page, or the User Waypoint page by pressing **MENU**, scrolling down to “Crossfill” with the **large right** knob and then pressing **ENT**. On the Aux Flight Planning page scroll down to “Crossfill” with the **large right** knob, and then press **ENT**.
2. Turn the **large right** knob to highlight the Method field. Turn the **small right** knob to select “Auto” or “Manual”. “Auto” automatically transfers any selection of (or any change to) a direct-to destination or active flight plan, including VNAV parameters, to a second 400W/500W-Series Garmin unit.

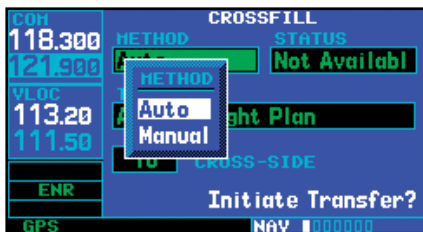

NOTE: Crossfill requires both 400W and/or 500W series units to have the same Jeppesen NavData® database cycle number.

3. The flashing cursor highlights the transfer data option (TRANSFER) field. Turn the **small right knob** to display a window of available data options:
 - **Active Flight Plan**—transfers the active flight plan, including VNAV parameters, to/from a second 400W-Series (or 500W-Series) Garmin unit in a dual unit installation. This option is the default when selecting “Crossfill” from the

default Nav Page. Active Flight Plan information is automatically transferred between units when the “Auto” method is selected above.

- **Flight Plan**—transfers any stored flight plan to/from a second 400W-Series (or 500W-Series) unit, by selecting the flight plan by number. This option is the default when selecting “Crossfill” from the Flight Plan Catalog.
- **User Waypoints (all)**—transfer all stored user waypoints to/from a second 400W/500W-series unit.
- **User Waypoint**—transfer the specified user waypoint to a second 400W/500W-series unit.

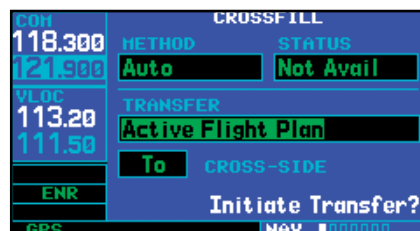

4. Continue turning the **small right** knob to highlight the desired data option. Press **ENT** select the highlighted option.
- 5a. For a stored flight plan (“Flight Plan” data option), the flight plan number field is highlighted. Turn the **small right** knob to select the desired flight plan and press **ENT**.

OR

- 5b. For a specified user waypoint ("UserWaypoint" data option), the waypoint identifier field is highlighted. Use the **small** and **large right** knobs to enter the identifier of the desired user waypoint. Press **ENT** when finished.
6. The flashing cursor moves to the "CROSS-SIDE" field. Turn the **small right** knob to select "To" or "From" and press **ENT**.
7. The flashing cursor moves to the "Initiate Transfer?" confirmation field. Press **ENT** to transfer the selected data.



Scheduler

To enter a scheduled message:

1. Select "Scheduler" from the flight planning page.
2. The flashing cursor highlights the first message field. If necessary, turn the **large right** knob to highlight the first blank message field.
3. Use the **small** and **large right** knobs to enter the message text. Press **ENT** when finished. (The 400W-series unit will store up to nine scheduled messages holding 20 characters each.)
4. The flashing cursor moves to the type field under the new message. Turn the **small right** knob to display a window of available options: (Event, One Time, Periodic). Press **ENT** to select.

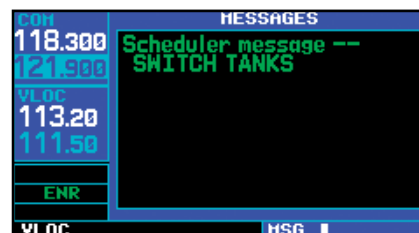
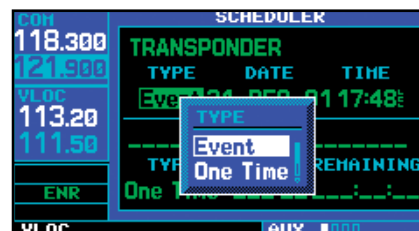

5. The flashing cursor moves to the time/date field. Use the **small** and **large right** knobs to set the time or date required before the message is displayed. Time is entered as hours/minutes (hhh:mm). Event-based messages expire at a specific date and time. Press **ENT**, when finished.

To edit a scheduled message:

1. Select "Scheduler" from the flight planning page.
2. The flashing cursor highlights the first message field.
3. To edit the message text, turn the **large right** knob to highlight the desired message field. Use the **small** and **large right** knobs to edit the message text—entering the new text directly over the old message. Press **ENT** when finished.

- To edit the time field, turn the **large right** knob to highlight the field. Use the **small** and **large right** knobs to edit the new date or time—entering the new value directly over the old figure. Press **ENT** when finished.

To delete a scheduled message:

- Select “Scheduler” from the flight planning page.
- The flashing cursor highlights the first message field. Turn the **large right** knob to highlight the desired message field.
- Press **CLR** to delete the message text, followed by **ENT** to confirm the deletion.

To perform Manual GTN Crossfill

The Manual GTN Crossfill Function allows the GNS 400W/500W series unit to manually send all User waypoints to the connected GTN unit or receive information from a GTN unit.



NOTE: *The databases of the 400/500 series and the 400W/500W are incompatible, so you may not mix systems.*



NOTE: *Manual GTN Crossfill requires the 400W/500W series unit to have the same Jeppesen NavData® database cycle number as the GTN unit.*



NOTE: *Crossfill and Manual GTN Crossfill can not be configured to be present at the same time. The chosen feature is configured by the installer for your installation.*



NOTE: *Ensure that the GTN unit has Auto GNS Crossfill enabled.*

The information received from the GTN unit includes the following:

- Active Waypoint Leg
- Active Flight Plan
- Direct-To Waypoint
- Suspend/OBS Status

Manual GTN Crossfill is a feature that will keep the GNS system in sync with a flight plan that is being used on the GTN system. The GTN will not automatically keep its flight plan in sync with changes made on the GNS system. Essentially, the crossfill feature is “one way” – from the GTN to the GNS.

The GTN systems support a variety of procedure leg types that the GNS systems do not support. As such, it is normal and expected that the flight plan leg that is displayed on the GNS system will not always match the flight plan leg on the GTN system. Departure, arrival and approach procedures often contain leg types that the GNS does not support. The GNS typically “skips” over these leg types and provides no guidance. Guidance may be available on the GTN but not on the GNS in these cases. The GNS will fly the procedure as it normally would if Crossfill were not active. Once a leg type is reached that is supported on both the GTN and GNS systems, the systems will automatically sync to the same leg.

Waypoint names longer than six characters, or duplicates, sent from the GTN unit to the GNS unit will replace some characters with a “+” sign, while leaving significant characters to aid in identification (such as, USR003 becomes US+003).

To Enable Flight Plan Crossfill from the GTN Unit

- From the Default NAV Page, Active Flight Plan page, or the User Waypoint page press **MENU**. Highlight "GTN Crossfill?" and then press **ENT**.

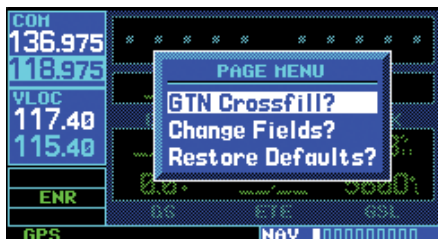

OR

- On the Aux Flight Planning page scroll down to "Manual GTN Crossfill" with the **large** or **small right** knob, and then press **ENT**.

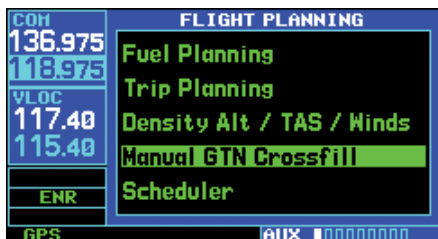

- With the Link field highlighted, turn the **small right** knob to show "Enabled", and then press **ENT**. This enables the GNS unit to receive flight plan information from the GTN unit.

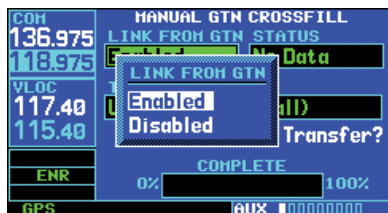

CAUTION: The user is required to always verify each flight plan leg prior to navigating with the GNS unit when Manual GTN Crossfill is active.



NOTE: If the user manually alters the flight plan on the GNS unit, the systems will not crossfill until the pilot activates the feature again on the

GNS unit.

To Transfer GNS User Waypoints to the GTN Unit

- Continuing from the steps above, turn the **large right** knob to highlight "Initiate Transfer?."

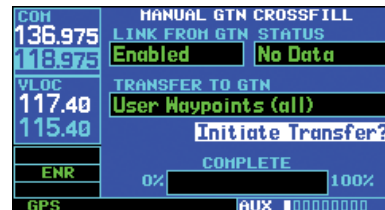

- Press **ENT**. The 400W/500W-series unit's User waypoints will be sent to the GTN unit.

Utility Page

The *utility page* provides access to checklists, a count down/up timer, trip timers, trip statistics, RAIM (Receiver Autonomous Integrity Monitoring) prediction, sunrise/sunset time calculations and software/database version information. When a Utility item is selected, the corresponding page will appear providing additional information and features.

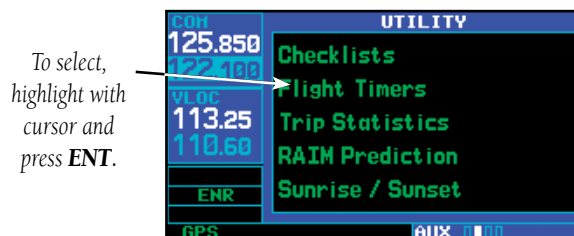

To select, highlight with cursor and press **ENT**.

Second Page
in AUX group

To select an item from the utility page:

- Press the **small right** knob momentarily, to activate the flashing cursor.
- Turn the **large right** knob to select the desired menu option, and press **ENT**.

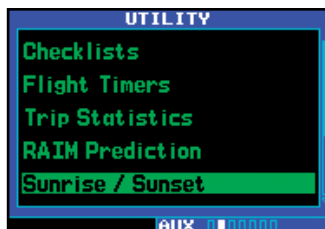

The following items are available:

Checklists— provides up to nine different user-defined checklists containing up to 30 items each.

Flight Timers— provides count up/down timers, plus automatic recording of departure time and total trip time. Departure and total trip time recording can be configured to run either any time 400W-series power is on, or only when your ground speed exceeds 30 knots.

In helicopter installations, flight timers will be only run if the air/ground switch indicates the aircraft is off the ground or if GPS air speed is greater than 20 kts.

Trip Statistics— provides readouts for trip odometers, average speed and maximum speed. These readouts are resettable (individually or all at once) by pressing **MENU** to display an options window.

RAIM Prediction— predicts if GPS coverage is available for your current location or at a specified waypoint at any time and date. Receiver Autonomous Integrity Monitoring performs checks to ensure that the 400W-series unit has adequate satellite geometry during your flight. RAIM avail-

ability is near 100% in Oceanic, En Route and Terminal phases of flight. Because the FAA's TSO requirements for non-precision approaches specify significantly better satellite coverage than other flight phases, RAIM may not be available when flying some approaches. The 400W-series unit automatically monitors RAIM during approach operations and warns you if RAIM is not available. In such cases, use the GNS 430W's VLOC receiver instead for the approaches. RAIM prediction helps you plan for a pending flight to confirm GPS operation during an approach.

RAIM prediction only predicts the availability of Fault Detection (FD) integrity in the absence of WAAS corrections. It cannot predict the availability of LPV approaches. The FAA provides a NOTAM service for LPV approach availability.



An "INTEG" annunciation at the bottom left corner of the screen indicates that satellite coverage is insufficient to pass built-in receiver autonomous integrity monitoring (RAIM) tests. When this occurs, the GPS receiver will continue to provide navigation information, but should not be used for primary navigation guidance. Use the GNS 430W's VLOC receiver or another suitable navigation source.

Sunrise / Sunset— allows you to calculate the time of sunrise and sunset at any waypoint or your present position for a specified date.

Software Versions — provides software version information for the operating software within the GPS receiver, COM transceiver, VOR/localizer receiver, glideslope receiver and main processor board.

Database Versions — The Database Versions Page displays the current Jeppesen database type, effective date, and expiration date, along with the version and type of built-in land database.

Terrain Database Versions — The Terrain Database Versions Page displays the current terrain and obstacle database types, version, cycle, effective date, and expiration date.

Checklists

To create a checklist:

1. Select "Checklist" from the utility page. Press **ENT** to display a list of checklists.

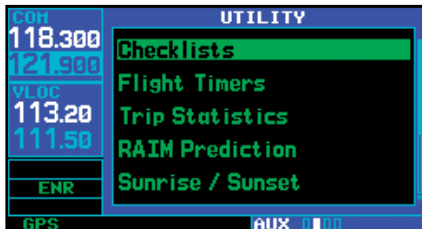

2. Press **MENU** to display an options menu. Turn the **large right** knob to select "Create New Checklist?" and press **ENT**.
3. Use the **small** and **large right** knobs to enter the name of a checklist. Press **ENT** when finished. (Up to nine different checklists can be created and stored in the 400W-series unit.)
4. Use the **small** and **large right** knobs to enter each checklist item, followed each time by **ENT**. (Each checklist may contain up to 30 line items of as much as sixteen characters long.)

To execute a checklist:

1. With the checklists page displayed, turn the **large right** knob to select the desired checklist and press **ENT**.

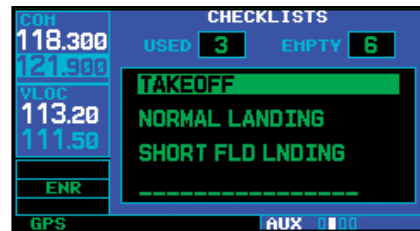

2. As you complete each checklist item, press **ENT** to move to the next item on the list.



To edit a checklist:

1. With the checklists page displayed, turn the **large right** knob to select the desired checklist and press **ENT**.
2. Press **MENU** to display an options menu. Select "Edit Item?" and press **ENT**, then use the **small** and **large right** knobs to edit each checklist item. Press **ENT** when finished.

To insert a checklist step into an existing checklist:

1. With the checklists page displayed, turn the **large right** knob to select the desired checklist and press **ENT**.
2. Turn the **large right** knob to highlight the existing checklist entry which will immediately follow the new checklist step.
3. Turn the **small** and **large right** knobs to enter the new checklist step. Press **ENT** when finished.

To delete a checklist or all checklists:

1. With the checklists page displayed, press **MENU** to display an options menu.
2. Turn the **large right** knob to select “delete checklist” or “delete all checklists” and press **ENT** to remove the checklist or all checklists from memory.

To copy a checklist:

1. With the checklists page displayed and the desired checklist selected, press **MENU**.
2. Turn the **large right** knob to select “Copy Checklist?” and press **ENT** to copy the checklist to an empty checklist memory location.

To sort the checklists by name or entry:

1. With the checklists page displayed, press **MENU** to display an options menu.
2. Turn the **large right** knob to select “Sort List By Entry?” or “Sort List By Name?” and press **ENT**.

Flight Timers

To view, use or reset the generic timer:

1. Select “Flight Timers” from the utility page.

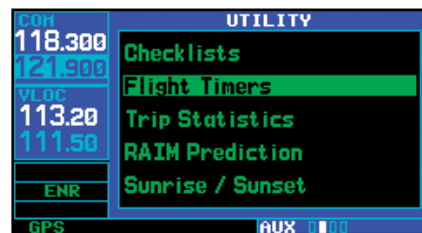

2. The flashing cursor highlights “Start?”. To start the generic timer, press **ENT**. (You will typically begin with this step for count up timers. However, for count down timers, you may wish to enter a count direction and time before starting the timer.)
3. To change the count direction, turn the **large right** knob to highlight count direction field: “Down” or “Up”. Turn the **small right** knob to select the desired count direction. Press **ENT** when finished.



4. For a count down timer, turn the **large right** knob to highlight the time field. Use the **small** and **large right** knobs to enter the count down time—in hours, minutes and seconds. Press **ENT** when finished.
5. To stop the generic timer, turn the **large right** knob to highlight “Stop?” and press **ENT**.
6. To reset the generic timer, turn the **large right** knob to highlight the time field. Press **CLR**, followed by **ENT**.

To record or reset the departure time:

1. Select "Flight Timers" from the utility page.
2. Turn the **large right** knob to highlight the reset mode field, under "Departure Time". (The reset mode field will indicate "Pwr-on" or "In Air".)
3. Turn the **small right** knob to select the desired reset mode. ("Pwr-on" will record a departure time when the 400W-series unit is turned on. "In Air" will record a departure time once the GPS-computed ground speed exceeds 30 knots.)



4. Press **ENT** when finished.
5. To reset the departure time, turn the **large right knob** to highlight "Reset?" and press **ENT**.

To view, use or reset total trip time:

1. Select "Flight Timers" from the utility page.
2. Turn the **large right** knob to highlight the reset mode field, under "Total Trip Time". (The reset mode field will indicate "Pwr-on" or "In Air".)
3. Turn the **small right** knob to select the desired reset mode. ("Pwr-on" will record trip time, in hours/minutes/seconds, any time the 400W-series unit is turned on. "In Air" will record trip time any time the GPS-computed ground speed exceeds 30 knots.)

In the case of a helicopter installation, the Total

Trip Criteria is "Pwr-on" or "In-air."

4. Press **ENT** when finished.
5. To reset the total trip time, turn the **large right** knob to highlight "Reset?" and press **ENT**.

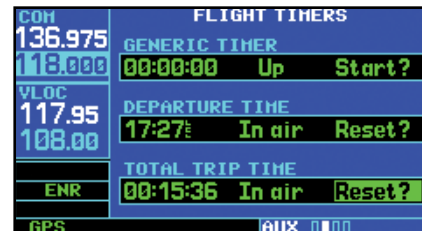
**Trip Statistics****To reset trip statistics readouts:**

1. Select "Trip Statistics" from the utility page.

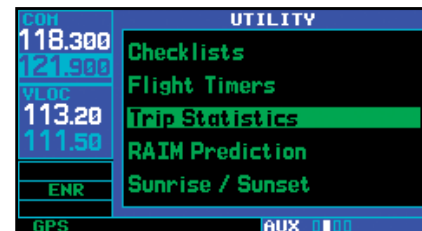

2. Press **MENU** to display an options window with several reset options:
 - Reset Trip?— Resets trip odometer and average ground speed readouts
 - Reset Max Speed?— Resets maximum speed readout only
 - Reset Odometer?— Resets odometer readout only
 - Reset All?— Resets all trip statistics readouts



- Turn the **large right knob** to select the desired reset option and press **ENT**.

RAIM Prediction

To predict RAIM availability:

- Select “RAIM Prediction” from the utility page.

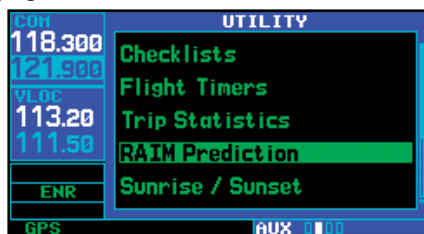

- The flashing cursor highlights the waypoint field. Use the **small** and **large right** knobs to enter the identifier of the waypoint at which you wish to determine RAIM availability. Press **ENT** when finished. (To determine RAIM availability for your present position, press **CLR**, followed by **ENT**.)

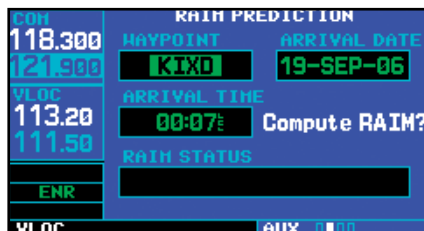

- The flashing cursor moves to the arrival date field. Use the **small** and **large right** knobs to enter the date for which you wish to determine RAIM availability. Press **ENT** when finished.
- The flashing cursor moves to the arrival time field. Use the **small** and **large right** knobs to enter the time for which you wish to determine RAIM availability. Press **ENT** when finished.

- The flashing cursor moves to “Compute RAIM?”. Press **ENT** to begin RAIM prediction. Once calculations are complete, the 400W-series unit will display one of the following in the RAIM status field:

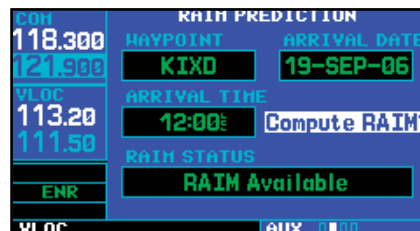

- RAIM Not Available— Satellite coverage is predicted to NOT be sufficient for reliable operation during non-precision approaches
- RAIM Available— Satellite coverage is predicted to be sufficient for reliable operation during all flight phases, including non-precision approaches



NOTE: RAIM computations predict satellite coverage within ± 15 minutes of the specified arrival date and time. Refer to the CDI/Alarms section of Aux pages Setup 1 for specific information regarding RAIM protection limits.

Sunrise / Sunset

To calculate sunrise and sunset times at any waypoint or your present position:

1. Select "Sunrise / Sunset" from the utility page.

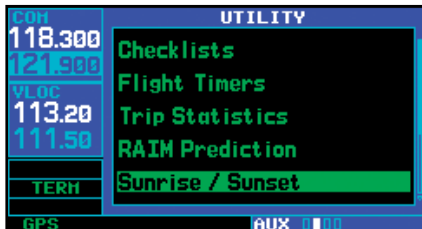

2. The flashing cursor highlights the waypoint field. Use the **small** and **large right** knobs to enter the identifier of the waypoint at which you wish to determine sunrise and sunset times. Press **ENT** when finished. (To determine sunrise/sunset times for your present position, press **CLR**, followed by **ENT**.)
3. The flashing cursor moves to the date field. Use the **small** and **large right** knobs to enter the date for which you wish to determine sunrise and sunset times.

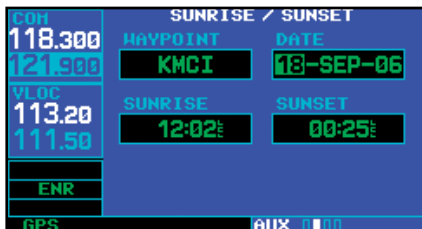

4. Press **ENT** to calculate sunrise and sunset times for the selected location and date.

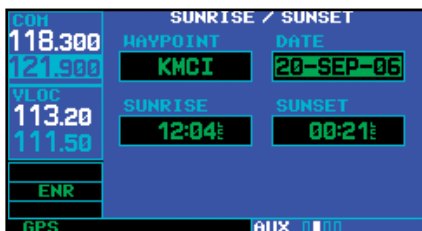

Software / Database Versions

The *software, database, and terrain database version pages* display software version information for each of the various subsystems contained within the 400W-series unit, as well as database versions for the Jeppesen NavData® card and built-in land data. These pages are for information purposes only—no user functions are available from this page. Reach these pages by turning the **small** or **large right** knobs and then press **ENT**. Press **CLR** or the **small right** knob to return to the *utility page*.

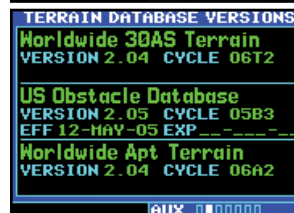

Setup 1 Page

The *Setup 1 page* provides access to airspace alarms, CDI scale adjustment, an arrival alarm, units of measure settings, position formats, map datums and settings for local or UTC time display. When a setup item is selected, the corresponding page will appear providing access to the various unit settings.

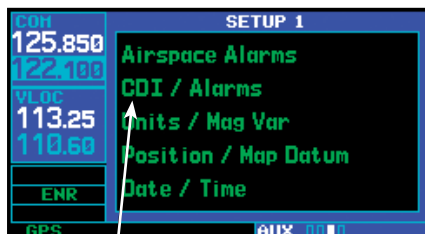

To select, highlight with cursor and press ENT.

Third Page in AUX group

To select a setup item from the setup 1 page:

1. Press the **small right** knob momentarily, to activate the flashing cursor.

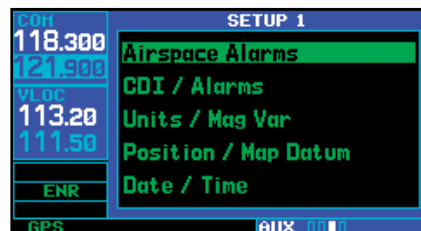

2. Turn the **large right** knob to select the desired setup item, and press ENT.

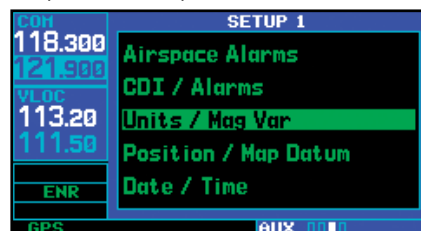

The following setup items are available:

Airspace Alarms— allows you to turn the controlled / special-use airspace message alerts on or off. This will not affect the alerts listed on the *nearest airspace page* or the airspace boundaries depicted on the map page. It will simply turn on/off the warning provided when you are approaching or near an airspace.

An altitude buffer is also provided which “expands” the vertical range above or below an airspace. For example, if the buffer is set at 500 feet, and you are

more than 500 feet above or below an airspace, you will not be notified with an alert message; if you are less than 500 feet above or below an airspace and projected to enter it, you will be notified with an alert message. The default is 200 feet.

CDI / Alarms— allows you to define the scale for the 400W-series unit on-screen course deviation indicator. The scale values represent full scale deflection for the CDI to either side. The default setting is “Auto”. At this setting, the CDI scale is set to 2.0 NM during the “en route” phase of flight. Within 31 NM of your destination airport, the CDI scale gradually ramps down to 1.0 NM (terminal area). Likewise, when leaving your departure airport the CDI scale is set to 1.0 NM and gradually ramps up to 2 NM beyond 30 NM (from the departure airport). During approach operations the CDI scale gradually transitions down to an angular CDI scale. At 2.0 NM of the final approach fix (FAF), CDI scaling is tightened from 1.0 to the angular full scale deflection (typically the angular full-scale deflection is 2.0°, but will be as defined for the approach).

If a lower CDI scale setting is selected (i.e., 1.0 or 0.3 NM), the higher scale settings are not selected during ANY phase of flight. For example, if 1.0 NM is selected, the 400W-series unit uses this for en route and terminal phases and ramps down further during an approach. Note that the Horizontal Alarm (HAL) protection limits listed below follow the selected CDI scale, unless corresponding flight phases call for lower HAL. For example, if the 1.0 NM CDI setting is selected, full-scale deflection during approach will still follow the approach CDI scale settings.

| CDI Scale | Horizontal Alarm Limit |
|----------------------------|------------------------|
| Auto (oceanic) | 2.0 NM |
| ±2.0 NM or Auto (en route) | 2.0 NM |
| ±1.0 NM or Auto (terminal) | 1.0 NM |
| ±0.3 NM or Auto (approach) | 0.3 NM |

An “auto” ILS CDI selection allows the 400W-series unit to automatically switch the external CDI from the GPS receiver to the VLOC receiver, when intercepting the final approach course. Or, select “manual” to manually switch the external CDI connection, as needed (using the **CDI** key). If the unit is installed with a KAP140/KFC225 autopilot, automatic switching will not take place. See AUX - Setup 1 for ILS CDI Selection details.

CDI scales and corresponding Flight Phases:



Oceanic



En Route



Terminal



Approach

An arrival alarm, provided on the CDI / Alarms Page, may be set to notify you with a message when you have reached a user-defined distance to the final destination (the direct-to waypoint or the last waypoint in a flight plan). Once you have reached the set distance (up to 99.9 units), an “Arrival at [waypoint]” message is displayed.

Units / Mag Var— allows you to configure the displayed data to standard or metric units of measure. This setting applies to distance, speed, altitude, fuel, pressure and temperature and also provides three variation (heading) options: Magnetic, True, or User. If “Magnetic” is selected, all track, course and heading information is corrected to the magnetic variation computed by the GPS receiver. The “True” setting references all information to true north. The “User” selection allows the pilot to enter values between 0° and 179° E or W.

Position / Map Datum— configures position readout information to the desired position format and shows the Map Datum. The NavData® card uses the WGS 84 map datum to conform to WAAS requirements.

Date / Time— provides settings for time format (local or UTC; 12- or 24-hour) and time offset. The time offset is used to define current local time. UTC (also called “GMT” or “zulu”) date and time are calculated directly from the GPS satellites’ signals and cannot be changed. If you prefer to use local time, simply designate the offset by adding or subtracting the correct number of hours and minutes.

Not all time zones are offset from UTC by a whole number of hours (e.g., Newfoundland, Central Australia, India, Iraq, ...).

Airspace Alarms

To set the airspace warning messages or change the altitude buffer:

1. Select “Airspace Alarms” from the setup 1 page.

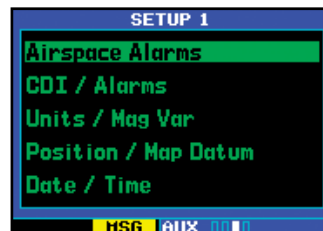

2. Turn the **large right** knob to highlight the “On”/“Off” field next to the desired airspace type.
3. Turn the **small right** knob to select “On” or “Off”, as desired. Press **ENT** to accept the selection.

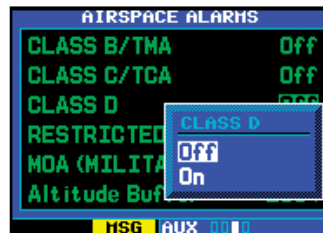

4. To change the altitude buffer, turn the **large right** knob to highlight the “Altitude Buffers” field. Use the **small** and **large right** knobs to enter the desired buffer distance. Press **ENT** when finished.





NOTE: When an approach has been loaded into the active flight plan, airspace alert messages will be disabled within 30 NM of the destination airport.

CDI Scale / Alarms

To change the CDI scale:

1. Select "CDI / Alarms" from the Setup 1 page.

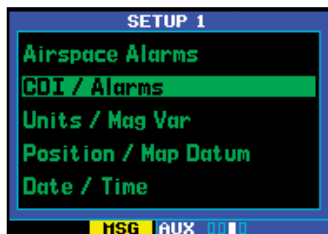

2. The flashing cursor highlights the "Selected CDI" field. Turn the **small right** knob to select the desired CDI scale. The selected scale and any lower scale settings will be used during the various phases of flight.
3. Press **ENT** to accept the selected scale. The "System CDI" field will display the CDI scale currently in use. The "System CDI" setting may differ from the "Selected CDI" depending upon the current phase of flight.

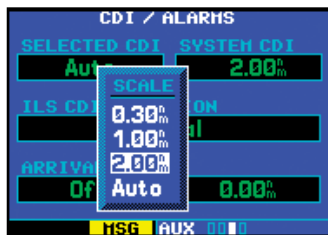

NOTE: The CDI scale is always measured in nautical miles, regardless of the current distance units of measure selected on the units/mag var page.

To change the ILS CDI selection:

1. Select "CDI / Alarms" from the setup 1 page.
2. Turn the **large right** knob to highlight the "Auto"/"Manual" ILS CDI field.
3. Turn the **small right** knob to select "Auto" or "Manual", as desired. Press **ENT** to accept the selection.



NOTE: Installations with certain autopilots, such as the KAP 140 and KFC225) do not allow automatic ILS CDI switching.

To set the arrival alarm and alarm distance:

1. Select "CDI / Alarms" from the setup 1 page.
2. Turn the **large right** knob to highlight the "On"/"Off" field (directly below "Arrival Alarm").
3. Turn the **small right** knob to select "On" or "Off", as desired. Press **ENT** to accept the selection.
4. The flashing cursor moves to the alarm distance field (to the immediate right of "On" or "Off"). To enter an arrival alarm distance, use the **small** and **large right** knobs to enter the desired alarm distance. Press **ENT** when finished.

Units / Mag Var

To set the magnetic variation:

1. Select "Units / Mag Var" from the Setup 1 page.

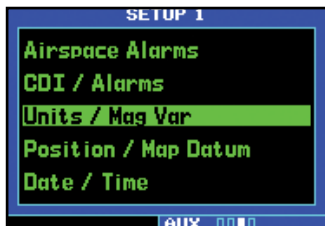

2. The flashing cursor highlights the heading mode field. Turn the **small right** knob to select the desired heading mode: Magnetic, True, or User. Press **ENT** to accept the selection.

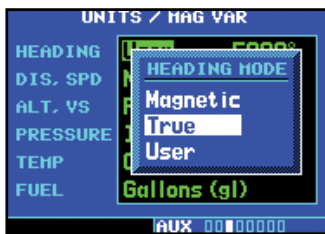

3. If User Heading is selected, the flashing cursor will highlight the Heading field. Turn the **small right** knob to the desired heading values, hemisphere and then degrees.



NOTE: Manual (User) selection of the heading value is available for units with SW Version 3.30, or later.

4. Press **ENT** to accept the selection.

To change the units of measure:

1. Select "Units / Mag Var" from the Setup 1 page.
2. Turn the **large right** knob to highlight the desired units of measure category. The following categories, and corresponding units of measure, are available:

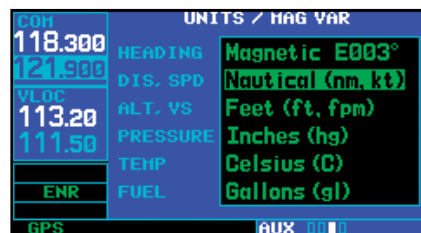

- **DIS, SPD**—distance and speed in Nautical (nautical miles/knots), Statute (miles/miles per hour) or Metric (kilometers/kilometers per hour) terms.
- **ALT, VS**—altitude and vertical speed in Feet/feet per minute, Meters/meters per minute, or Meters/meters per second.
- **PRESSURE**—barometric setting in Inches or Millibars.
- **TEMP**—temperature in degrees Celsius or Fahrenheit.
- **FUEL**—fuel units in Gallons, Imperial Gallons, Kilograms, Liters or Pounds.

3. Turn the **small right** knob to select the desired units of measure for the selected category. Press **ENT** to accept the selection.

Position Format

To change the position format:

1. Select "Position Format / Map Datum" from the Setup 1 page.



2. The flashing cursor is on the position format field. Turn the **small right** knob to select the desired position format. The following position formats are available:



- **hddd°mm.mmm'**—latitude and longitude in degrees and decimal minutes
 - **hddd°mm'ss.s"**—latitude and longitude in degrees, minutes and decimal seconds
 - **MGRS**—Military Grid Reference System
 - **UTM/UPS**—Universal Transverse Mercator / Universal Polar Stereographic grids
3. Press **ENT** to accept the selected format.

Map Datum



NOTE: Per TSO C146a, the WGS-84 map datum is used.

Date / Time

To display local time or UTC:

1. Select "Date / Time" from the Setup 1 page.
2. The flashing cursor highlights the time format field. Turn the **small right** knob to display a window of available time formats: Local 12hr, Local 24hr, or UTC.



3. Continue turning the **small right** knob to select the desired time format.
4. Press **ENT** to accept the selection.

To set the local time:

1. Select "Date / Time" from the Setup 1 page.
2. Turn the **large right** knob to highlight the time offset field.



3. Use the **small** and **large right** knobs to enter the desired offset, beginning by entering a minus (-) or plus (+) sign to indicate whether the offset is behind UTC or ahead of UTC. (In

9 - AUX PAGES

Setup 2

the United States, all local time offsets will use be minus, or behind UTC.)

4. Press **ENT** to accept the selected offset.

Restoring Factory Settings

When making changes to any *setup 1 page* option, a “Restore Defaults?” menu selection allows you to restore the original factory settings (for the selected item only). For example, with the *airspace alarms page* displayed, the “Restore Defaults?” option will restore all *airspace alarms page* settings to the original factory values.

To restore a Setup 1 item to the original factory settings:

1. Select the desired item from the Setup 1 page.
2. Press **MENU** to display a page options window.



3. With “Restore Defaults?” highlighted, press **ENT**.

Setup 2 Page

To select, highlight with cursor and press ENT.



Fourth Page in AUX group

The *Setup 2 page* provides access to display adjustments, parameters which define the nearest airport search, and COM transceiver channel spacing. When an item is selected, the corresponding page will appear providing access to the various unit settings.

To select an item from the Setup 2 page:

1. Press the **small right** knob momentarily, to activate the flashing cursor.

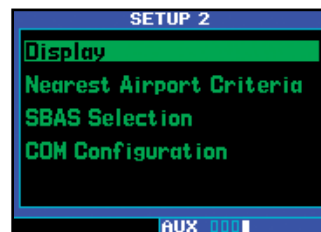

2. Turn the **large right** knob to select the desired setup item, and press **ENT**.

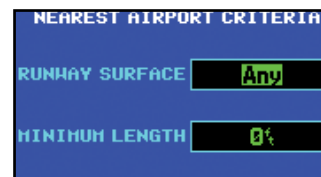
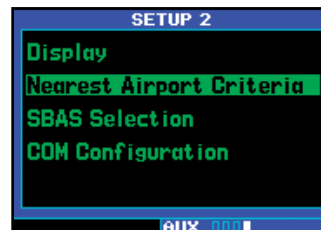

The following setup items are available:

Display— allows you to adjust the display for optimum viewing in any condition. Automatic back-lighting is available which uses a built-in photocell (at the top left corner of the display bezel) to make the proper display adjustments without any user intervention. Automatic contrast adjustment varies the screen contrast level based upon current unit temperature. You may also select manual control of the display contrast and backlighting to tailor the 400W-series unit display to your needs.



NOTE: *Display backlighting changes are not saved when the 400W-series unit is turned off. Backlighting will revert to the "Auto" setting the next time the unit is turned on.*

Nearest Airport Criteria— defines the minimum runway length and surface type used when determining the 25 nearest airports to display on the *nearest airport page*. A minimum runway length and/or surface type may be entered to prevent airports with small runways, or runways that are not of appropriate surface, from being displayed. The default settings are "0 feet (or meters)" for runway length and "any" for runway surface type.

SBAS Selection— selects the Space Based Augmentation System (SBAS) used for navigation and allows turning WAAS on and off. To enable WAAS operation, in the Setup 2 page select the SBAS (Space-Based Augmentation System) item and then select WAAS. If WAAS is disabled, the unit will not be able to fly WAAS approaches (LP, LPV, LP +V, LNAV/WNAV, or LNAV+V).

If WAAS was previously disabled, it may take several minutes to achieve a 3D-Diff fix after re-enabling WAAS.

COM Configuration— allows you to select 8.33 kHz or 25.0 kHz COM frequency channel spacing.



NOTE: *8.33 kHz VHF communication frequency channel spacing is not approved for use in the United States. Select the 25.0 kHz channel spacing option.*

To set the COM channel spacing:

1. Select "COM Configuration" and press ENT.
2. Turn the **small right** knob to select "8.33 kHz" or "25.0 kHz" and press ENT.



Preset Com Frequencies

On units configured for COM Frequency Presets you may store up to 15 preset Com frequencies in the Com Configuration page. On units configured with a remote Com frequency recall switch, these preset frequencies can be loaded into the STBY frequency with the press of a button.



NOTE: *Preset Com Frequencies are only available with SW Version 3.00, or later.*

To store a preset Com frequency:

1. Select "COM Configuration" from the Setup 2 Page.
2. The flashing cursor will highlight the Channel Spacing field. Turn the **large right** knob to highlight the left (non-decimal) part of the first frequency field.
3. Turn the **small right** knob to select the desired frequency.

9 - AUX PAGES

Setup 2

- Turn the **large right** knob to highlight the right (decimal) part of the frequency field.



- Turn the **small right** knob to enter the desired frequency.
- Repeat for any remaining desired frequencies, then press the **small right** knob to finish.

When the remote Com frequency recall switch is pressed, the next preset frequency will be moved into the Com Standby frequency box and a small window with the current Com Frequency Preset number will appear next to it. You can scroll down through the preset frequencies by repeatedly pressing the remote Com Frequency recall switch. Empty Preset slots are skipped.



Display

To change the backlighting intensity:

- Select "Display" from the Setup 2 page.



- The flashing cursor highlights the backlight mode field. Turn the **small right** knob to select the desired mode: Auto or Manual. Press **ENT** to accept the selection.

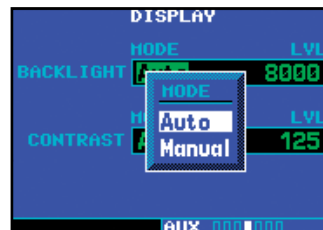

- If "Manual" is selected, the flashing cursor moves to the backlight level field. Turn the **small right** knob to select the desired level. Press **ENT** to accept the selection.

To change the display contrast:

Contrast setting is adjustable in either Auto or Manual Mode. Auto mode is the preferred setting. The contrast value edited in Auto Mode is not the actual contrast, but an offset that is applied to the automatic value generated by the formula based on unit temperature.

- Select "Display" from the Setup 2 page.
- Turn the **large right** knob to highlight the contrast mode field.
- Turn the **small right** knob to select the desired mode: Auto or Manual. Press **ENT** to accept the selection.
- The flashing cursor moves to the contrast level field. Turn the **small right** knob to select the desired level. Press **ENT** to accept the selection.



Nearest Airport Criteria

To set the minimum runway length and runway surface:

1. Select "Nearest Airport Criteria" from the Setup 2 page.
2. The flashing cursor highlights the runway surface field. Turn the **small right** knob to select the desired surface. The following options are available:
 - Any surface
 - Hard surfaces only
 - Hard / Soft surfaces
 - Water landings only



3. Press **ENT** to accept the runway surface selection.
4. The flashing cursor moves to the minimum runway length field. To enter a different minimum runway length, use the **small** and **large right** knobs to enter the desired length. Press **ENT** when finished.



NOTE: Exercise caution when changing the Nearest Airport Criteria. Remember, by excluding certain

surface types or shorter runway lengths, you may be excluding airports from the list that are more than adequate for an emergency landing!

SBAS Selection

To enable WAAS operation, in the Setup 2 page select the SBAS item and then select WAAS. If WAAS is disabled, the unit will not be able to fly WAAS approaches (LP, LPV, LP +V, LNAV/VNAV, or LNAV+V).

If WAAS was previously disabled, it may take several minutes to achieve a 3D-Diff fix after re-enabling WAAS.

1. Select "SBAS Selection" from the Setup 2 Page and press **ENT**.



To enable WAAS operation, select the "SBAS Selection".

2. The flashing cursor highlights the WAAS status selection. Turn the **small right** knob to allow On/Off selection.

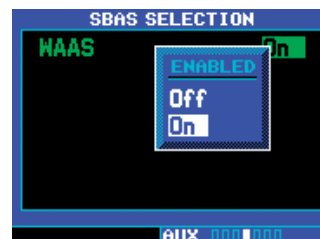

Turn the small right knob to select On or Off and then press **ENT**.

3. Turn the **small right** knob to select "On" or "Off" and then press **ENT**. Press the **small right** knob to exit WAAS selection.



NOTE: There may be other SBAS selections available, such as MSAS.

Section 10

Fault Detection & Exclusion

The Garmin 400W-series software incorporates a Fault Detection and Exclusion (FDE) algorithm, thus providing a basis for approval per FAA Notice N8110.60 requirements for “GPS as a Primary Means of Navigation for Oceanic/Remote Operations”.

The FDE consists of two distinct features, fault detection and fault exclusion. The fault detection feature detects the presence of an unacceptably large pseudorange error for a satellite (and presumably, position error) for a given mode of flight. Upon detection, fault exclusion follows and excludes the source of the unacceptably large pseudorange error, thereby allowing navigation to return to normal performance without an interruption in service. To enhance safety, FDE functionality is provided for other phases of flight (non-precision approach, terminal, en route). The FDE functionality for non-oceanic flight phases complies with missed alert probability, false alert probability and failed exclusion probability specified by DO-229C / TSO-C146a.

Detection and Exclusion

An FDE prediction must be performed prior to departure for a flight plan involving Oceanic/Remote operation where GPS is to be the sole source of navigation. Prior to departure, the operator must use the FDE prediction program supplied with the 400W/500W-series Trainer CD to demonstrate that there are no outages in the capability to navigate on the specified route of flight (the FDE prediction program determines whether the GPS constellation is robust enough to provide a navigation solution for the specified route of flight). Please, refer to the instructions included in the Garmin 400W/500W-series

Training CD for complete details on using the FDE prediction program.

Section 11 Messages, Abbreviations, and Navigation Terminology

Messages

The 400W-series unit uses a flashing “MSG” annunciator at the bottom of the screen (directly above the **MSG** key) to alert you of any important information or warnings. While most messages are advisory in nature, warning messages may require your intervention.

Whenever the “MSG” annunciator flashes, press the **MSG** key to display the message, when pilot workload allows. Press **MSG** again to return to the previous page.

The following is a list of available messages and their meanings:

ABORT APPROACH — Loss of Navigation — Execute missed approach using other navigation equipment.

ADS-B traffic has failed — The ADS-B traffic system may have lost GPS position or detected an internal fault. Contact dealer for service.

ADS-B transmit has failed — ADS-B unit is not able to transmit a message due to a failure with the ADS-B system or antenna(s). Contact dealer for service.

ADS-B is not transmitting position — The ADS-B unit has detected a position input fault. Contact dealer for service.

ADS-B fault - Check ADS-B Status Page — A fault has been detected. Check the ADS-B unit Status page in Aux mode.

ADS-B - Connection has been lost — The GNS is configured for a traffic device but is not receiving data from it. Traffic will not be displayed on the GNS. Contact dealer for service.

ADS-B Traffic Alerting not available — The ADS-B traffic system is reporting that the CSA application has failed. Traffic alerting on ADS-B traffic is unavailable. Ensure the aircraft has a clear view of the sky. If the problem persists. Contact dealer for service.

Airport terrain database integrity error — The 400W-series unit has detected a problem with a database on the Terrain data card. The data is not usable and the card should be returned to your Garmin dealer.

Airspace ahead — less than 10 minutes — Your GPS-calculated course is projected to enter a special use airspace within 10 minutes. This message is automatically disabled within 30 NM of an arrival airport, when an approach is loaded.

Airspace near and ahead — Your GPS-calculated position is within 2 NM of the boundary of a special use airspace and your course is projected to enter the airspace. This message is automatically disabled within 30 NM of an arrival airport, when an approach is loaded.

All data referenced to True North — The unit does not have a valid aviation database, so it cannot compute magnetic variation.

Approach downgraded — Use LNAV minima — This message will occur 60 seconds prior to the FAF if flying LNAV+V, L/VNAV, LP, LP +V, or LPV approaches and WAAS integrity parameters have fallen below minimal limits. As a result, vertical guidance has been discontinued and the LP, LPV, LP +V, LNAV+V, or L/VNAV approach you were flying has been downgraded.

Approach is not active — The approach could not transition to “active”, at 2 NM or closer to the FAF. Verify that “SUSP” DOES NOT appear directly above the **OB**s key, indicating the auto waypoint sequencing is suspended.

Approaching target altitude — The current GPS-computed altitude is within 500 feet of the final Vertical Navigation target altitude.

Approaching VNAV profile — You are within one minute of reaching the initial Vertical Navigation descent point.

APR Guidance Available - Use PROC before A/P APR — For units configured with the KAP140 or KFC225 autopilot, this message reminds pilots, when they turn on course to the FAF, that they need to enable autopilot outputs (by pressing **PROC** and selecting “Enable A/P APR Outputs?”) before switching the autopilot control panel to APR.

Arrival at waypoint [waypoint name] — You are within the arrival alarm circle for the indicated waypoint. The size of the arrival alarm circle is defined from the “CDI / alarms” menu option on the Setup Page.

Audio database integrity error — The 400W-series unit has detected a problem with the built-in HTAWS Audio Database. HTAWS audio alerts are not available. The unit should be returned to your Garmin dealer for service.

Aviation database integrity error — The 400W-series unit has detected a problem with a database on the NavData® card. The data is not usable and the card should be returned to Jeppesen or your Garmin dealer for service.

Bad geometry, parallel offset not activated — parallel offset is not activated because of flight plan geometry.

Basemap database integrity error — The 400W-series unit has detected a failure in the built-in basemap (land data) database. Land data does not appear on the Map Page. Other unit functions continue to work normally, however the 400W-series unit should be taken to your Garmin dealer for service at your earliest convenience.

Boot block verify failed - Return unit for repair — System integrity testing has determined that the boot block has become corrupted. Return the unit to your Garmin dealer for service.

Cannot navigate locked FPL — You have attempted to navigate a flight plan (FPL) with one or more locked waypoints. A waypoint can be “locked” when the NavData® card is replaced and the waypoint(s) does not exist in the new database or if attempting to crossfill user waypoints when no empty user-defined waypoint slots exist (will create a “lockd” point in flight plan).

Can't change an active waypoint — An attempt has been made to modify the position of the active “to” or “from” waypoint. The 400W-series unit does not allow modifications to user waypoints currently being utilized for navigation guidance.

Can't delete an active or FPL waypoint — An attempt has been made to delete the active “to” or “from” user waypoint. The 400W-series unit does not allow you to delete user waypoints currently being utilized for navigation guidance.

CDI key stuck — The **CDI** key is stuck in the enabled (or “pressed”) state. Try pressing the **CDI** key again to cycle its operation. Check for proper operation of both the internal and remote keys (if present). If the message persists, contact your Garmin dealer for assistance.

CDI key disabled — The installation has disabled the CDI key so that systems (such as an EFIS) connected to the 400 series unit will always have GPS deviation data on one output (main) and VLOC deviation data on the other output (Nav). See your installer for more information.

Check unit cooling — The 400W-series unit has detected excessive display backlighting temperature. The backlighting has been automatically dimmed to reduce the temperature. Check for adequate ventilation or check cooling airflow. Contact your Garmin dealer for assistance.

COM has failed — (GNS 430W/GNC 420W only) A failure has been detected in the communications transceiver. The COM transceiver is not available and the unit should be returned to your Garmin dealer for service.

COM is not responding — (GNS 430W/GNC 420W only) Internal system-to-system communication between the main processor and the COM transceiver has failed. Operational status of the COM transceiver is unknown and the unit should be returned to your Garmin dealer for service. If the Com board is still working, it will automatically tune to 121.500 MHz. Transmit and receive functions may still operate regardless of the displayed frequency.

COM needs service — (GNS 430W/GNC 420W only) A failure in the communications transceiver has been detected. The COM transceiver may still be usable, but the unit should be returned (at your earliest convenience) to your Garmin dealer for service.

COM push-to-talk key stuck — (GNS 430W/GNC 420W only) The external push-to-talk (PTT) switch is stuck in the enabled (or “pressed”) state. Try pressing the PTT switch again to cycle its operation. If the message persists, contact your Garmin dealer for assistance.

COM remote transfer key is stuck — (GNS 430W/GNC 420W only) The remote COM transfer switch is stuck in the enabled (or “pressed”) state. Try pressing the switch again to cycle its operation. If the message persists, contact your Garmin dealer for assistance.

COM transfer key stuck — (GNS 430W/GNC 420W only) The **COM flip-flop** key is stuck in the enabled (or “pressed”) state. Try pressing the **COM flip-flop** key again to cycle its operation. If the message persists, contact your Garmin dealer for assistance.

COM transmitter power has been reduced — (GNS 430W/GNC 420W only) Excessive unit temperature and/or an insufficient voltage level has been detected. The COM transceiver transmit power has been automatically reduced to compensate for the condition. For excessive temperatures, check for adequate ventilation or check cooling air flow. If the message persists, contact your Garmin dealer for assistance.

Configuration error - Config service req'd — The configuration information provided by the installer has been lost or corrupted. Contact your Garmin dealer for service.

Data transfer cancelled (crossfill is busy) — An attempt to transfer flight plan data during a unit-to-unit crossfill was cancelled. The host unit is busy. Wait until any previous crossfill operation is complete, before re-attempting the transfer.

Data transfer cancelled (data invalid) — An attempt to transfer a single user waypoint during a unit-to-unit crossfill was cancelled. No waypoint was specified on the Crossfill Page. Select a user waypoint and re-attempt the transfer.

Data transfer cancelled (version mismatch) — An attempt to transfer data during a unit-to-unit crossfill was cancelled. The database versions of the two 400W-series unit are not identical. If necessary, update the database(s) so they match.

Contact Jeppesen or your Garmin dealer for assistance.

Data transfer error, please re-transmit — An error was detected during unit-to-unit crossfill of user data (user waypoints and/or flight plans). The data transfer should be re-attempted.

Data transfer is complete — The unit-to-unit crossfill of all user waypoint data has finished.

Database changed, validate user modified procedures — You have modified one or more approaches, departures or arrivals from their original published form. When the NavData® card is replaced (database update), you must manually verify your changes in the new database. This message occurs each time a flight plan containing a modified procedure (generated from a prior database version) is activated. To eliminate the message, re-create the flight plan from the new database, then make the desired modifications.

Display backlight failure — The 400W-series unit has detected a failure in the display backlighting. The unit should be taken to your Garmin dealer for service.

Do not use for navigation — The 400W-series unit is in Demo Mode and must not be used for actual navigation.

FPL has been truncated — The flight plan (FPL) was truncated because not enough room existed to insert an approach, departure or arrival. This may occur upon power up when a database change increases the number of waypoints within an instrument procedure.

FPL is full — remove unnecessary waypoints — An attempt has been made to add more than 100 waypoints to a flight plan (FPL). The 400W-series unit does not allow more than 100 waypoints per flight plan.

FPL waypoint is locked — At least one flight plan (FPL) waypoint is locked because the waypoint has been removed from the current NavData® card (database change), the data card is missing, or the data card has failed.

FPL waypoint moved — The position data for one or more flight plan (FPL) waypoints moved at least 0.33 arc minutes in the current NavData® card (database change).

G/S has failed — (GNS 430W only) A failure in the glideslope receiver has been detected. The glideslope receiver is not available and the unit should be returned to your Garmin dealer for service.

G/S is not responding — (GNS 430W only) Internal system-to-system communication between the main processor and the glideslope receiver has failed. Operational status of the glideslope receiver is unknown and the unit should be returned to your Garmin dealer for service.

G/S needs service — (GNS 430W only) A failure in the glideslope receiver has been detected. The glideslope receiver may still be usable, but the unit should be returned (at your earliest convenience) to your Garmin dealer for service.

GAD configuration required — The GAD 42 Interface Adapter has lost the configuration information stored in its internal memory. Any mechanical indicators connected to your 400W-series unit are unusable and the GAD 42 should be returned to your Garmin dealer for service.

GAD needs service — The 400W-series unit has detected a failure in the GAD 42 interface adapter. Any mechanical indicators connected to your 400W-series unit are unusable and the GAD 42 should be returned to your Garmin dealer for service.

GDL 69 is not responding — No data is being received from the GDL 69. If the problem persists, contact your Garmin dealer for service.

GDL 88 is unable to transmit ADS-B messages — The GDL 88 is reporting that it has a problem transmitting ADS-B messages. The unit may not be transmitting ADS-B information correctly and the traffic picture may be degraded.

GDL 88 Service Required — The GDL 88 is reporting that it has a problem with receiving ADS-B data. The unit may continue to function, but the traffic picture may be degraded.

GDL 88 Traffic Failure — The GDL 88 is reporting that it has a problem processing all traffic information. The traffic function of the GDL 88 is unavailable.

GDL 88 ADS-B traffic has failed or GDL 88 Traffic Failure — The GDL 88 is reporting that it has a problem processing ADS-B traffic data. The ADS-B traffic picture may be degraded.

GDL 88 Traffic Alerting not available or GDL 88 CSA Failure — The GDL 88 is reporting that the CSA application has failed. Traffic alerting on ADS-B traffic is unavailable.

GDL 88 Connection has been lost — The GNS unit cannot communicate with the datalink. Data from the datalink will not be available.

GDL 88 ADS-B transmit has failed — The GDL 88 is unable to transmit. If the problem persists, contact your Garmin dealer for service.

GDL 88 ADS-B is not transmitting position — The GDL 88 is not transmitting. If the problem persists, contact your Garmin dealer for service.

GDL 88 ADS-B fault - Check GDL 88 Status Page — A fault has been detected. Check the GDL 88 Status page in Aux mode.

GPS is not responding - Check GPS antenna — Internal system-to-system communication between the main processor and the GPS receiver has failed. Operational status of the GPS receiver is unknown and the unit should be returned to your Garmin dealer for service after first checking antenna connections or for a short in the antenna.

GPS needs service — The 400W-series unit has detected a failure in its GPS receiver. The GPS receiver may still be usable, but the unit should be returned (at your earliest convenience) to your Garmin dealer for service.

GTN transfer canceled version mismatch — The GNS and GTN units are using different Navigation Database cycles.

GTN flight plan not supported — The GTN active flight plan contains a waypoint that is not recognized by the GNS, e.g. GTN has a European waypoint and the GNS Navigation Database is North America only.

Inside airspace — Your GPS-calculated position lies within the boundaries of a special use airspace. This message is automatically disabled within 30 NM of an arrival airport, when an approach is loaded.

Insufficient Terrain Database Resolution — The installed terrain database does not have sufficient resolution to support HTAWS.

Invalid closest pt of FPL — A closest point cannot be created from the waypoint entered on the “Closest point of flight plan” window. This occurs when the selected waypoint is beyond the limits of all legs in the flight plan, too far away, or when a unique waypoint name for the closest point cannot be created.

Invalid FPL modification — An attempt was made to modify the final course segment (FAF to MAP) of an instrument approach. The 400W-series unit does not allow the modifications.

Invalid waypoint ident — An attempt was made to create a user waypoint with an invalid name. The 400W-series unit does not allow spaces between characters in the waypoint name.

Large magnetic variance — Verify all course angles — A valid value of magnetic variation is not available for this location. Check all course angles manually.

Loss of GPS Navigation - Use other NAV if available — The Dead Reckoning annunciator appears on the left side of the map display when GPS position is unavailable and the unit is in Dead Reckoning mode. Dead Reckoning mode will continue until GPS position is restored.

Loss of integrity — cross-check NAV — The GPS position does not meet necessary criteria. Use other navigation devices to verify your position and navigation.

Low Battery - Unit Needs Service — Time data may have been lost due to a memory battery failure.

MAIN processor requires service — The 400W-series unit has detected a failure in the main system processor. The 400W-series unit is not usable and should be taken to your Garmin dealer for service.

Near airspace — less than 2 NM — Your GPS-calculated position is within 2 NM of a special use airspace boundary, but you are not projected to enter the airspace. This message is automatically disabled within 30 NM of an arrival airport, when an approach is loaded.

No altitude input is being received — No altitude data is being received from RS-232 (Serializer: Icarus, Rosetta or Shadin) or grey code inputs. If the problem persists, contact your Garmin dealer and check the installation and installation settings.

No basemap data available — The 400W-series unit has detected a failure in the built-in basemap (land data) memory. Land data does not appear on the Map Page. Other unit functions continue to work normally, however the 400W-series unit should be taken to your Garmin dealer for service at your earliest convenience.

NON WGS84 WPT — Do not use GPS for nav to [xxxxx]. The position of the selected waypoint [xxxxx] is not calculated based on the WGS84 map reference datum and may be positioned in error as displayed. Do not use GPS to navigate to the selected non-WGS84 waypoint.

Non-WGS84 wpt navigation [xxxxx]. — The position of the selected waypoint [xxxxx] is not calculated based on the WGS84 map reference datum and may be positioned in error as displayed. Do not use GPS to navigate to the selected non-WGS84 waypoint.

Not receiving input data on 429 Channel #1 or #2 — No data has been received on the ARINC 429 channel connection for a period exceeding five seconds. If the problem persists, the installation should be checked by your Garmin dealer.

Not receiving input data on 232 Channel #(1 through 4) — No data has been received on one (or more) of the RS-232 channel connections for a period exceeding ten seconds. If the problem persists, the installation should be checked by your Garmin dealer.

Not receiving traffic data — No traffic data is being received. If the problem persists, the installation should be checked by your Garmin dealer.

NRST key stuck – The **NRST** key is stuck in the enabled (or “pressed”) state. Try pressing the **NRST** key again to cycle its operation. If the message persists, contact your Garmin dealer for assistance.

OBS key stuck — The **OBS** key is stuck in the enabled (or pressed) state. Try pressing the **OBS** key again to cycle its operation. Check for proper operation of both the internal and remote keys (if present). If the message persists, contact your Garmin dealer for assistance.

OBS not available — The **OBS** mode could not be activated, because 1) no destination waypoint has been selected, or 2) the GPS receiver cannot currently determine its position.

Obstacle database integrity error — The 400W-series unit has detected a problem with a database on the HTAWS/Terrain data card. The data is not usable and the card should be returned to your Garmin dealer for service.

Position outside terrain database coverage region – This is supplemental information to explain why “TER N/A” is being annunciated.

RAIM position warning — Although sufficient GPS satellite coverage may exist, Receiver Autonomous Integrity Monitoring (RAIM) has determined the information from one or more GPS satellites may be in error. The resulting GPS position may be in error beyond the limits allowed for your current phase of flight. Cross-check your position with an alternate navigation source. If the warning occurs during a final approach segment (FAF to MAP), execute the published missed approach.

Scheduler message [1-9] — [user entered text] — The user-entered scheduler message time has expired, and the scheduler message is displayed.

Searching the sky — The 400W-series unit is searching the sky for GPS satellites.

Select appropriate frequency for approach — You are inbound and within 3 NM of the FAF; and the active VLOC frequency does not match the published frequency for the approach. Tune the standby VLOC frequency to the proper frequency and press the **VLOC flip-flop** key to “activate” the frequency.

Select VLOC on CDI for approach — (GNS 430W only) You are inbound and within 3 NM of the FAF; and the active approach is not a GPS-approved approach. Verify that the VLOC receiver is tuned to the proper frequency and press the **CDI** key to display “VLOC” (directly above the **CDI** key).

Set course to [###]° — The course select for the external CDI (or HSI) should be set to the specified course. The message only occurs when the current selected course differs from the desired track by 10°, or greater.

Steep turn ahead — This message appears approximately one minute prior to a turn in one of the following three conditions: 1) the turn requires a bank angle in excess of 25° in order to stay on course, 2) the turn requires a course change greater than 175°, or 3) during a DME arc approach the turn anticipation distance exceeds 90 seconds.

Stored data was lost — All user waypoints, flight plans and system settings have been lost due to a system reset.

Stormscope device has failed — The 400W-series unit cannot communicate with the WX-500 and/or the WX-500 is reporting a system failure.

Stormscope heading has failed — The WX 500 is reporting invalid heading data. The failure may be within the WX 500 or other connected equipment.

TAWS has failed — The 400W-series unit has detected a failure in its HTAWS system. The most likely cause is a missing or corrupt Terrain database. If the Terrain database is not the cause, the unit should be returned to your Garmin dealer for service.

TAWS inhibit key stuck — The external HTAWS inhibit key is stuck.

TAWS mute caution key is stuck — The external HTAWS aural suppression input is stuck.

TAWS reduced protection key is stuck — The external HTAWS reduced protection key is stuck.

TCAD altitude data invalid — If the Ryan TCAD has an altitude failure, the TCAD will announce an altitude failure aurally (“TCAD ALTITUDE DATA INVALID”) but continue operating. The relative altitude for the targets will be invalid.

TERRAIN configuration conflict — The current HTAWS/Terrain configuration is not supported by the hardware. The TAWS hardware may have failed, or the unit may be misconfigured. The unit’s terrain capabilities will be downgraded to “Terrain Proximity” instead of “HTAWS”. Contact your Garmin dealer for service.

TERRAIN configuration has changed — The unit’s terrain/HTAWS settings have changed since it was last turned on in normal mode. Contact your Garmin dealer for service.

Terrain database integrity error — The 400W-series unit has detected a problem with a database on the HTAWS/Terrain data card. The data is not usable and the card should be returned to your Garmin dealer for service.

TERRAIN has failed — The unit has detected a failure in the terrain system. The most likely cause is a missing or corrupt Terrain database. Terrain functionality is not available. If the Terrain database is not the cause, the unit should be returned to your Garmin dealer for service.

Timer has expired — The count down timer has reached zero.

Traffic device has failed — The 400W-series unit cannot communicate with the SKY497 or TCAD and/or the SKY497 or TCAD is reporting a system failure. This can also be displayed due to GDL 88 failure.

Traffic device needs service — the traffic device is reporting a system failure. The unit may still be usable, but should be returned (at your earliest convenience) to your Garmin dealer for service.

True north approach - Change Mag Var HDG to true — The selected approach requires navigation information be referenced to true north. In the AUX function, change Heading Mode to “true.”

User card format unknown — A data card has been inserted, but the format of the card is not recognized.

User Magnetic Variation is active – Note that “User” is selected on the AUX -- Units/Mag Var page and the magnetic variation value provided on that page is being used.

VLOC has failed — The GNS 430W has detected a failure in its VLOC receiver. The VLOC receiver is not available and the unit should be returned to your Garmin dealer for service.

VLOC is not responding — (GNS 430W only) Internal system-to-system communication between the main processor and the VLOC receiver has failed. Operational status of the VLOC receiver is unknown and the unit should be returned to your Garmin dealer for service.

VLOC needs service — (GNS 430W only) A failure in the VLOC receiver has been detected. The VLOC receiver may still be usable, but the unit should be returned (at your earliest convenience) to your Garmin dealer for service.

VLOC remote transfer key is stuck — (GNS 430W only) The remote VLOC transfer switch is stuck in the enabled (or “pressed”) state. Try pressing the switch again to cycle its operation. If the message persists, contact your Garmin dealer for assistance.

VLOC transfer key stuck — (GNS 430W only) The **VLOC flip-flop** key is stuck in the enabled (or “pressed”) state. Try pressing the **VLOC flip-flop** key again to cycle its operation. If the message persists, contact your Garmin dealer for assistance.

Waypoint already exists — The name you have entered for a user waypoint already exists in memory.

Waypoint(s) have been replaced — One or more user waypoints were updated during a unit-to-unit crossfill operation.

Waypoint memory is full — You have used all 1000 user waypoint locations in the 400W-series unit memory. Delete unwanted waypoints to make room for new entries.

Turn Advisory and Arrival Annunciations

The following annunciator messages may appear in the lower right corner of the 400W-series unit display:

ARRIVING WPT — Arriving at the destination waypoint for the active leg (waypoint alert).

DTK xxx° xx S — Waypoint alert. Prepare to turn to the indicated heading upon waypoint passage.

HOLD DIRECT — “Direct” holding pattern entry.

HOLD PARALLEL — “Parallel” holding pattern entry.

HOLD TEARDROP — “Teardrop” holding pattern entry.

LT TO xxx° xx S — Turn advisory. Turn to the indicated heading by the time shown.

LT TO xxx° NOW — Turn advisory. Turn to the indicated heading now.

PTK END xx S — Parallel Offset is terminating by the time shown.

RT TO xxx° xx S — Turn advisory. Turn to the indicated heading by the time shown.

RT TO xxx° NOW — Turn advisory. Turn to the indicated heading now.

Flight Plan Transfer Messages

FPL imported successfully — The Flight Plan file contained Route Points (that is, it didn’t contain only User Waypoints) and there were no errors when importing them to the target position within the unit’s Flight Plan Catalog.

WPT import successful - No FPL data was modified — The Flight Plan file contained one or more User Waypoints and there were no errors when adding them to the User Database.

Flight plan import failed — The unit failed to load any information from the Flight Plan file. (Neither the Flight Plan Catalog nor the User Database was modified.)

File contains wpts only — The Flight Plan file did not contain any Route Points but one or more User Waypoints were imported successfully.

FPL import message(s): — The Flight Plan file contained Route Points (it didn’t contain only Waypoints) and there were some errors or warnings (see below). Some or all information was imported successfully.

FPL too long, truncated (appended to the import results text) — The Flight Plan file contained more Route Points than a flight plan can support.

Invalid FPL wpt(s) locked (appended to the import results text) — The Flight Plan file contained one or more Waypoints that could not be found in the navigation database or imported into the User Database.

User wpt database full - Not all waypoints loaded (appended to the import results text) — One or more of the User Waypoints in the Flight Plan file were not created because the unit’s User Database is full (or became full during the import operation).

User waypoint(s) renamed (appended to the import results text) — One or more of the User Waypoints in the Flight Plan file was renamed during the import operation.

Verify FPL before use (appended to the import results text) — One or more of the User Waypoints or Route Points to be imported were modified in some way (one or more of messages [f] through [i] were displayed) and changes should be verified before using the flight plan for navigation.

Abbreviations

The following is a list of abbreviations used on the 400W-series unit and their meanings:

ACTV— Active

ALT— Altitude

APR— Approach

APT— Airport

ARSPC— Airspace

ARTCC— Air Route Traffic Control Center

ARVL— Arrival

AUX— Auxiliary

AVGAS— Aviation-grade Gasoline

AVTN— Aviation

BARO— Barometric setting

BRG— Bearing To

°C— Degree Celsius

C/V— COM/VLOC

CAS— Calibrated Airspeed

CDI— Course Deviation Indicator

CLR— Clear

COM— Communications Transceiver

CRSR— Cursor

CTA— ICAO Control Area

CTAF— Common Traffic Advisory Frequency

CTR— Center (see ARTCC)

CUM— Cumulative

DB— Database

DEN— Density

DEP— Departure

DEPT— Departure guidance

DIS— Distance

DME— Distance Measuring Equipment

DTK— Desired Track

EFF— Efficiency

ELEV— Elevation

ENDUR— Endurance

ENR— En Route

ENT— Enter

EPU— Estimated Position Uncertainty

ESA— En Route Safe Altitude

ETA— Estimated Time of Arrival

ETE— Estimated Time En Route

°F— Degrees Fahrenheit

FAF— Final Approach Fix

FF— Fuel Flow

FIR— Flight Information Region

FLTA— Forward Looking Terrain Avoidance

FOB— Fuel On Board

FPL— Flight Plan

fpm— Feet Per Minute

FREQ— Frequency

FSS— Flight Service Station

ft— Feet

11 - MESSAGES ABBREVIATIONS & NAV TERMS

| | | | |
|------------------|--|-----------------|---|
| G/S — | Glideslope | lb — | Pounds |
| gal — | gallons | LCL — | Local |
| GPS — | Global Positioning System | LFOB — | Left-over Fuel On Board |
| GS — | Ground Speed | LNAV — | Lateral Navigation only |
| HAL — | Horizontal Alarm Limit | LNAV+V — | Lateral Navigation with advisory vertical guidance |
| HDG — | Heading | LOC — | Localizer |
| HFOM — | Horizontal Figure of Merit | LP — | Lateral Precision Performance |
| hg — | Inches of Mercury | LPV — | Lateral Precision Performance with Vertical Guidance |
| HPL — | Horizontal Protection Level | LP +V — | Lateral Precision Performance with Advisory Vertical Guidance |
| HWY — | Highway | LRES — | Left-over Fuel Reserve Time |
| IAF — | Intermediate Approach Fix | Lrg — | Large |
| ID — | Identifier | lt — | Liters |
| ig — | Imperial Gallons | °M — | Degrees Magnetic |
| ILS — | Instrument Landing System | m — | Meters |
| IND — | Indicated | MAP — | Missed Approach Point |
| INT — | Intersection | MAHP — | Missed Approach Hold Point |
| INTEG — | Integrity | MAPR — | Missed Approach guidance |
| ITI — | Imminent Terrain Impact | mb — | Millibars of Pressure |
| kg — | Kilograms | Med — | Medium |
| kHz — | Kilohertz | MGRS — | Military Grid Reference System |
| km — | Kilometers | MHz — | Megahertz |
| kph — | Kilometers Per Hour | mi — | Statute Miles |
| kt — | Knots | MOA — | Military Operations Area |
| L/VNAV — | Lateral and vertical navigation guidance, LNAV/VNAV service level | mph — | Statute Miles Per Hour |
| LAT/LON — | Latitude/Longitude | mpm — | Meters Per Minute |
| | | mps — | Meters Per Second |
| | | MSA — | Minimum Safe Altitude |

| | | | |
|--------------------|--|------------------|---|
| MSG — | Message | SBAS — | Space-Based Augmentation System |
| MSL — | Mean Sea Level | SID — | Standard Instrument Departure |
| mul — | Multicom | Sml — | Small |
| NATNL — | National | SPD — | Speed |
| NAV — | Navigation | SQ — | Squelch |
| NAVAID — | Navigational Aid | SRFC — | Surface |
| NDB — | Non-Directional Radio Beacon | STAR — | Standard Terminal Arrival Route |
| NM — | Nautical Miles | SUA — | Special Use Airspace |
| NRST — | Nearest | SUSP — | Waypoint sequencing suspended |
| NUM — | Number | | |
| | | °T — | Degree True |
| OBS — | Omnibearing Selector | TACAN — | Tactical Air Navigation |
| OCN — | Oceanic | TAS — | True Airspeed |
| | | TAT — | Total Air Temperature |
| PDA — | Premature Descent Alert | TEMP — | Temperature |
| PPOS — | Present Position | TER — | Terrain |
| PROC — | Procedure(s) | TERM — | Terminal |
| PROV — | Province | TKE — | Track Angle Error |
| PTK — | Parallel Track | TMA — | ICAO Terminal Control Area |
| PWR — | Power | TRANS — | Transition |
| | | TRFC — | Traffic |
| RAD — | Radial | TRK — | Track (also Ground Track) Angle |
| RAIM — | Receiver Autonomous Integrity Monitoring | TRSA — | Terminal Radar Service Area |
| REF — | Reference | twr — | Tower |
| REQ — | Required / Requirements | TX — | Transmit |
| RESTRICTD — | Restricted | | |
| RNG — | Range | uni — | Unicom |
| RTC — | Required Terrain Clearance | UTC — | Coordinated Universal Time (also GMT or “zulu”) |
| RX — | Receive | UTM/UPS — | Universal Transverse Mercator / Universal Polar Stereographic grids |

11 - MESSAGES ABBREVIATIONS & NAV TERMS

- VAL**— Vertical Alarm Limit
- VAR**— Variation
- VER**— Version
- VFOM**— Vertical Figure of Merit
- VFR**— Visual Flight Rules
- VLOC**— VOR/Localizer Receiver
- VNAV**— Vertical Navigation
- VOL**— Volume
- VOR**— VHF Omnidirectional Radio Range
- VPL**— Vertical Protection Level
- VS**— Vertical Speed
- VSR**— Vertical Speed Required

- WAAS**— Wide Area Augmentation System
- WPT**— Waypoint
- WX**— Weather

- XTK**— Crosstrack Error

Navigation Terms

The following navigation terms are used on the 400W-series and in this Pilot's Guide:

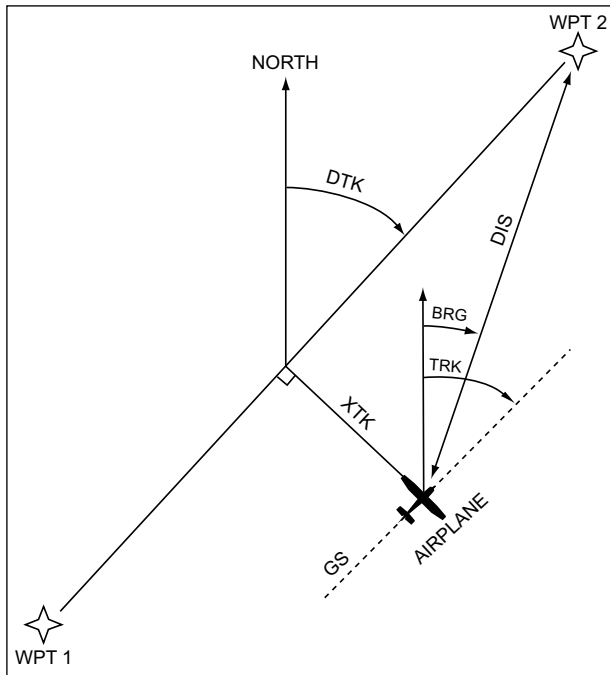

ALT (altitude)— Height above mean sea level (MSL).

BRG (bearing)— The compass direction from your present position to a destination waypoint.

CAS (calibrated airspeed)— Indicated airspeed corrected for instrument errors.

CUM (cumulative)— The total of all legs in a flight plan (such as “cumulative distance”).

DIS (distance)— The geodesic path from your present position to a destination waypoint.

DTK (desired track)— The desired course between the active “from” and “to” waypoints.

EFF (efficiency)— A measure of fuel consumption, expressed in distance per fuel units (e.g., nautical

miles per gallon).

ENDUR (endurance)— Flight endurance, or total available flight time based upon available fuel.

EPU (estimated position uncertainty)— A measure of satellite geometry quality and additional factors, expressed as a horizontal position error in feet or meters.

ESA (en route safe altitude)— The recommended minimum altitude within ten miles, left or right, of your desired course on an active flight plan or direct-to.

ETA (estimate time of arrival)— The estimated time at which you will reach your destination waypoint, based upon current speed and track.

ETE (estimated time en route)— The time it will take to reach the destination waypoint, from present position, based upon current ground speed.

FF (fuel flow)— The fuel flow rate, expressed in fuel units per time (e.g., gallons per hour).

FOB (fuel on board)— The total amount of usable fuel on board the aircraft.

Geodesic — an arc path that follows the shortest distance along an ellipsoid model of the earth (WGS-84). A geodesic is more accurate than a “great circle” which assumes a perfect sphere model of the earth.

GS (ground speed)— The velocity you are travelling relative to a ground position.

HDG (heading)— The direction an aircraft is pointed, based upon indications from a magnetic compass or a properly set directional gyro.

IND (indicated)— Information provided by properly calibrated and set instrumentation in the aircraft panel (e.g., “indicated altitude”).

LFOB (left-over fuel onboard)— The amount of fuel remaining on board after the completion of one or more legs of a flight plan (or a direct-to).

LRES (left-over fuel reserve)— The amount of fuel remaining on board after the completion of a one or more legs of a flight plan (or a direct-to), expressed in time and based upon a known fuel consumption (flow) rate.

MSA (minimum safe altitude)— Uses Grid Minimum Off-route Altitudes (Grid MORAs) to determine a safe altitude within ten miles of your present position. Grid MORAs are one degree latitude by one degree longitude in size and clear all reference points within the grid by 1000 feet in areas where the highest reference point is 5000 feet MSL or lower. If the highest reference point is above 5000 feet, the Grid MORA will clear the highest reference point by 2000 feet.

TKE (track angle error)— The angle difference between the desired track and your current track. An arrow indicates the proper direction to turn to reduce TKE to zero.

TRK (track)— The direction of movement relative to a ground position. Also referred to as “ground track”.

VSR (vertical speed required)— The vertical speed necessary to descend from current position and altitude to a defined target position and altitude, based upon your current ground speed.

XTK (crosstrack error)— The distance you are off a desired course in either direction, left or right.

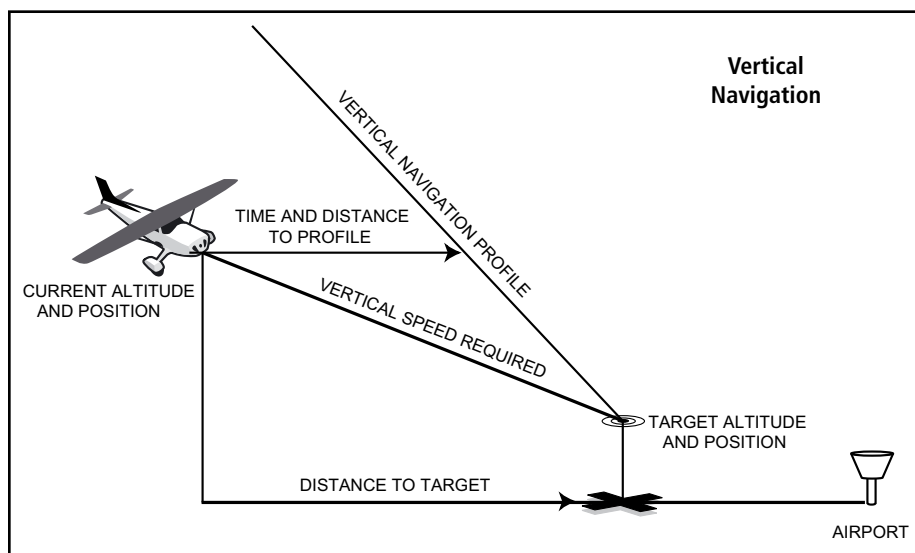

Appendix A NavData Card Use

The Jeppesen NavData® card supplied with your 400W-series unit can be installed or removed when the 400W-series unit is off. Insert the card with the swing arm handle at the bottom and the label facing to the left (see illustration right). If the NavData card is not present when the unit is turned on, you will receive a “No Jeppesen Aviation Database - Limited to user defined waypoints” message on the *database confirmation page*. If the NavData card is removed during operation, a “Data card removed-Unit will restart in 30 seconds” warning. The 400W-series unit will automatically reinitialize even if the card is reinserted. You may also reinitialize the unit manually by pressing **ENT**.

To insert the NavData card:

1. Place the card into the NavData card slot, with the label facing to the left and the swing arm handle at the bottom front.



NOTE: There are two data card slots on the face of the 400W-series. The Jeppesen NavData® card should be inserted in the left-most slot. The second slot is provided for the terrain card.

2. Press the NavData card into place until it seats on the internal connector and the front of the card is flush with the face of the 400W-series unit.
3. If the swing arm handle is up, gently lower the handle and push it into place—flush with the face of the 400W-series unit.

To remove the NavData card:

1. Gently press on the tab—using a slight upward motion—at the front center of the NavData card. This will partially deploy the swing arm handle.
2. Turn the swing arm handle upward (and outward) until it locks into place, perpendicular to the face of the 400W-series unit.
3. Grasp the top and bottom surfaces of the swing arm handle, between your thumb and forefinger, and pull directly away from the face of the 400W-series unit to unseat the connector and remove the NavData card.

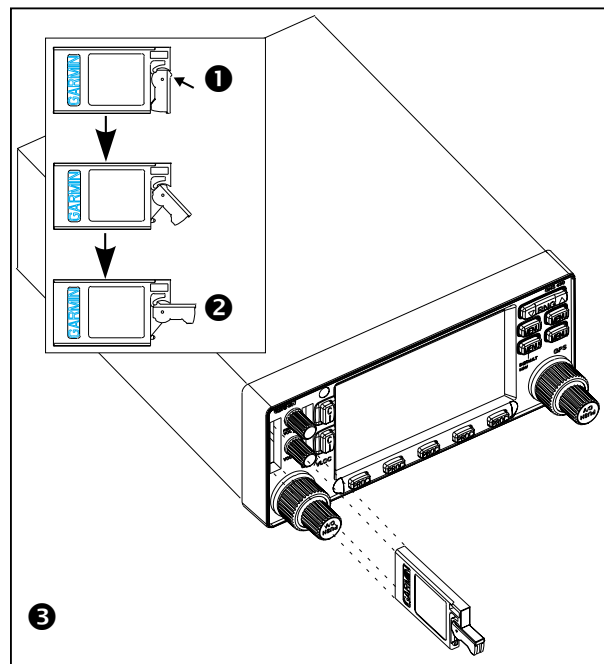

Appendix B Specifications

PHYSICAL

Unit Size: 6.25"W x 11.00"D x 2.69"H
(159 mm x 279 mm x 68 mm)

Unit Weight with tray:

| | |
|------------|-------------------|
| 400W | 5.0 lbs (2.27 kg) |
| 420W/420AW | 5.5 lbs (2.49 kg) |
| 430W/430AW | 6.2 lbs (2.61 kg) |

POWER

| | | |
|--------|----------------|-----------|
| Input: | 400W/420W/430W | 14/28 Vdc |
| | 420AW/430AW | 28 Vdc |

ENVIRONMENTAL

Temperature: -20°C to +55°C (operating range)
(-4°F to +131°F)

Humidity: 95% non-condensing

Altitude: -1,500 ft to 50,000 ft
(-457 m to 15,240 m)

GPS PERFORMANCE

Receiver: 15 parallel channel (12 + 3 WAAS)

Time to First Fix: 1 min 45 sec

Update Rate: Five per second, continuous

Accuracy: Position — < 1.25 m RMS horizontal
< 2 m vertical, with WAAS

Dynamics: 1000 kt maximum velocity

VHF COM PERFORMANCE (GNS 430W only)

Channels: 760 (25 kHz spacing) or
2280 (8.33 kHz spacing)

Frequency Range: 118.000 MHz to
136.992 MHz

Transmit Power: 10 watts minimum
(GNS 430W/GNC 420W)
16 watts minimum
(GNS 430AW/GNC 420AW)

VOR PERFORMANCE (GNS 430W/AW only)

Frequency Range: 108.00 MHz to
117.95 MHz

LOCALIZER PERFORMANCE

(GNS 430W/AW only)

Frequency Range: 108.10 MHz to
111.95 MHz

GLIDESLOPE PERFORMANCE

(GNS 430W/430AW only)

Frequency Range: 329.15 MHz to 335.00 MHz

INTERFACES

- Garmin GDL 69/69A
- ARINC 429
- Aviation RS-232
- CDI/HSI
- RMI (digital: clock/data)
- Superflag Out
- Altitude (serial: Icarus, Shadin-Rosetta or encoded: Gillham/Greycode)
- Fuel Sensor
- Fuel/Air Data
- L3 WX 500 Stormscope
- L3 SKY497 SkyWatch
- TIS from GTX 330
- Ryan 9900B TCAD

Appendix C Troubleshooting Q&A

This section is designed to answer some of the common questions regarding the 400W-series capabilities and operation. If you have a problem operating the unit, read through this appendix and refer to the reference section noted. If you don't find answers to your particular question here, use the index to find the appropriate section elsewhere in this manual. If, after reading through the appropriate reference section, you still haven't found the answer to your question, please see your authorized dealer or contact GARMIN directly at the address or phone numbers listed on page ii. GARMIN is dedicated to supporting its products and customers.

What is RAIM, and how does it affect approach operations?

RAIM is an acronym for Receiver Autonomous Integrity Monitoring, a GPS receiver function that performs a consistency check on all tracked satellites. RAIM ensures that the available satellite geometry will allow the receiver to calculate a position within a specified protection limit (4 NM for oceanic, 2 NM for en route, 1 NM for terminal and 0.3 NM for non-precision approaches).

During oceanic, en route and terminal phases of flight, RAIM will be available nearly 100% of the time. Because of the tighter protection limit on approaches, there may be times when RAIM is not available. The 400W-series unit automatically monitors RAIM and will warn you with an alert message (see Section 11) when it is not available, and the INTEG annunciator (**INTEG**) will appear at the bottom left corner of the screen. If RAIM is not available when crossing the FAF, the pilot must fly the missed approach procedure. The 400W-series unit RAIM prediction function will also allow you to see whether RAIM will be available for a specified date and time.



NOTE: RAIM prediction is not directly related to WAAS integrity.

RAIM integrity prediction is performed by the internal GPS receiver and is performed at all times. WAAS integrity is reported by the WAAS satellite system and only works within the WAAS service volume. WAAS approaches require WAAS integrity. Outside of the WAAS service volume, such as an Oceanic flight, RAIM prediction will be used.

Why aren't there any approaches available for my flight plan?

Approaches are available for the final destination airport in a flight plan or as a direct-to (keep in mind that some VOR/VORTAC identifiers are similar to airport identifiers). If a destination airport does not have a GPS approach, the 400W-series unit will indicate "NONE" for the available procedures—as listed on the *airport approach page*. For more information on selecting an approach, see Section 4 - Flight Plans, Select Approach.



What happens when I select an approach? Can I store a flight plan with an approach, departure or arrival?

Whenever you load an approach, departure or arrival into the active flight plan, a set of approach, departure or arrival waypoints is inserted into the flight plan—along with a header line describing the instrument procedure you selected. The original en route portion of the flight plan will remain active, unless you “Activate” the instrument procedure; which may be done when the procedure is loaded or at a later time.



Flight plans can also be stored with an approach, departure or arrival. Keep in mind that the active flight plan is erased when the unit is turned off and overwritten when another flight plan is activated. When storing flight plans with an approach, departure or arrival, the 400W-series unit will use the waypoint information from the current database to define the waypoints. If the database is changed or updated, the 400W-series unit will automatically update the information if the procedure has not been modified. If an approach, departure or arrival procedure is no longer available, the flight plan will become locked until the procedure is deleted from the flight plan or the correct database is installed. For information on loading an approach, departure or arrival. See Section 4 - Flight Plans for instructions on saving and copying flight plans.

Can I file slant Golf (“/G”) using my GPS?

Yes, you may file your flight plan as /G if your 400W-series unit is an authorized IFR installation. The 400W series is a TSO C146a Gamma-3 (Class 3) authorized GPS navigator. If you are flying en route, you may file /G with an expired database only after you have verified all route waypoints. Approaches may not be flown with an expired database. See your approved Airplane Flight Manual Supplement for more information.

What does the OBS key do and when do I use it?

The OBS key is used to select manual (OBS mode) or to suspend automatic sequencing of waypoints. Activating OBS mode (as indicated by an **OBS** annunciation directly above the OBS key) holds your current “active to” waypoint as your navigation reference and prevents the GPS from sequencing to the next waypoint. When OBS mode is cancelled, automatic waypoint sequencing is selected, and the 400W-series unit will automatically select the next waypoint in the flight plan once the aircraft has crossed the present active-to waypoint.

| NORMAL (no “OBS” annunciator) | OBS |
|--|---|
| Automatic sequencing of waypoints | Manual sequencing- “holds” on selected waypoint |
| Change in HSI does not affect CDI deflection | Manually select course to next waypoint from HSI |
| Always navigates “TO” the active waypoint | Will indicate “TO” or “FROM” waypoint |
| Must be in this mode for final approach course | Cannot be set for final approach course or published holding patterns |

Whenever OBS mode is active, the 400W-series unit allows you to select the desired course to/from a waypoint using the HSI (much like a VOR) and display a to/from

flag for the active-to waypoint. If an external course input is not available, you may select the OBS course on-screen, via a “Select OBS Course” pop-up window. With OBS mode cancelled, the CDI will always display a “TO” indication for the next waypoint once you’ve crossed the active waypoint (provided the active waypoint is not the last waypoint). Refer to *Section 5 - Flying the Missed Approach* for an example using the OBS key.



One application for the **OBS** key is holding patterns. The **OBS** key is used to suspend waypoint sequencing and select the desired course along the waypoint side of the hold. For many approach operations, setting and resetting of waypoint sequencing is automatic. Holding patterns that are part of an approach will automatically disable waypoint sequencing, then re-enable waypoint sequencing after one time around the holding pattern. A “SUSP” annunciation will appear directly above the **OBS** key (see illustration left) to indicate that automatic waypoint sequencing is temporarily suspended and course selection is not available. If more than one trip around the holding pattern is desired, press the **OBS** key to again suspend waypoint sequencing. An example of this operation is an approach which begins with a holding pattern at the initial approach fix (IAF). *Section 5 - Flying an Approach with a Hold* for more information on the “SUSP” annunciation and approaches with holding patterns.

When should I use the OBS key to return to auto sequencing, and what happens when I do?

The most common application for using the **OBS** key is the missed approach. The 400W-series unit will suspend automatic waypoint sequencing (indicated by a “SUSP” annunciation directly above the **OBS** key; see right) when you cross the missed approach point (MAP). This prevents the 400W-series unit from automatically sequencing to the missed approach holding point (MAHP). If a missed approach is required, press the **OBS** key to return to automatic waypoint sequencing and sequence the approach to the MAHP. See *Section 5 - Flying the Missed Approach* for more information on missed approaches.



Why won't my unit automatically sequence to the next waypoint?

The 400W-series unit will only sequence flight plan waypoints when automatic sequencing is enabled (i.e., no “OBS” or “SUSP” annunciation directly above the **OBS** key). For automatic sequencing to occur, you must also cross the “bisector” of the turn you are navigating. The bisector is a line that bisects the angle formed by two flight plan legs; it passes through the waypoint common to both legs.

How do I skip a waypoint in an approach, departure, or arrival?

The 400W-series unit allows you to manually select any approach, departure or arrival leg as the active leg of your flight plan. This procedure is performed from the *active flight plan page* by highlighting the desired waypoint and pressing **direct-to** twice, then **ENT** to approve the selection (see illustration right). The GPS will then provide navigation along the selected flight plan leg, so be sure you have clearance to that position.



NOTE: If activating a leg while on the From side, sequencing will be suspended as indicated with the **SUSP** annunciation shown above the **OBS** key.

How do I fly the GPS with an autopilot and DG heading bug?

If you do not have an HSI, you should make your course selections on the external CDI's **OBS** knob and the DG heading bug.

When does turn anticipation begin, and what bank angle is expected?

The 400W-series unit will smooth adjacent leg transitions based upon a nominal 15° bank angle (with the ability to increase the bank angle up to 30°) and provide three pilot cues for turn anticipation:

- 1) A waypoint alert (“LT or RT to ###° x S”) will flash in the lower right corner of the screen 10 seconds before the turn point.
- 2) A flashing turn advisory (“LT or RT TO ###° NOW”) will appear in the lower right corner of the screen

when you are to begin the turn. Set the HSI to the next DTK value and begin the turn.

- 3) The To/From indicator on the HSI (or CDI) will flip momentarily to indicate that you have crossed the midpoint of the turn. For more information on waypoint alerts and turn advisories, see section 5.

When does the CDI scale change, and what does it change to?

The CDI scale is 1.0 NM (terminal mode) within 31 NM of the departure airport. The CDI will smoothly scale to 2.0 NM (en route mode) once beyond 31 NM from the departure airport.

The unit begins a smooth CDI scale transition from the 2.0 NM (en route mode) to the 1.0 NM (terminal mode) scale within 31 NM from the destination airport. When within 45° of the final approach course and the FAF is the TO waypoint, the 400W-series unit switches from terminal mode to approach mode. CDI scaling is tightened from 1.0 NM full scale deflection to either 0.3 NM or 2° full scale deflection whichever is less at the FAF. The scaling change occurs gradually over a 2 NM distance and is completed before crossing the FAF.

If Vectors to Final is selected, the unit provides CDI scaling appropriate to the approach, which is typically ± 2 degrees angular from the origin of the approach. This angular course deviation reaches the max ± 1 NM deviation at approximately 27 NM from the MAP. The course width and angular deviation for GPS approaches are similar to what is provided for VHF localizer signals. (see the figure – Full-Scale deflection and defined path for VTF approach).

If a missed approach is executed, the CDI scale will change to ± 0.3 NM or ± 1.0 NM, as described in *Section 5 - Procedures - Flying the Missed Approach*.

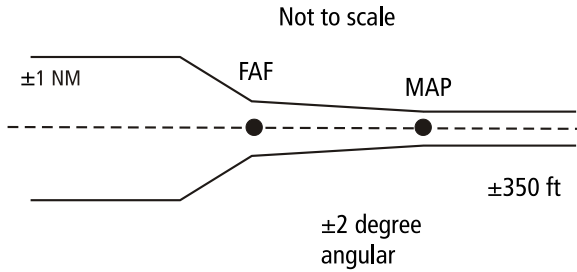

Full-Scale deflection and defined path for normal approach

Sensitivity must change from ±1 NM FSD to either ±0.3 NM or ±2° FSD, whichever is less at the FAF. Change occurs over 2 NM and is completed at the FAF.

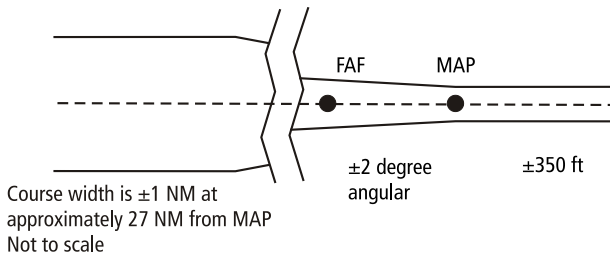

Full-Scale deflection and defined path for VTF approach

Why does my CDI not respond like a VOR when OBS mode is active?

Unlike a VOR, the CDI scale used on GPS equipment is based on the cross-track distance to the desired course, in OBS mode not an angular relationship to the destination. Therefore, the CDI deflection on the GPS will be constant regardless of the distance to the destination, and will not become less sensitive when you are further away from the destination.

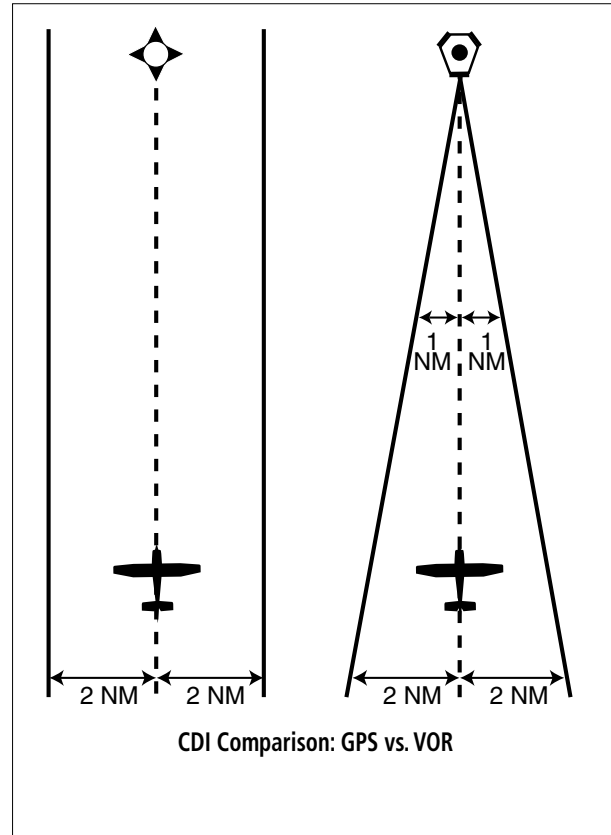

What is the correct missed approach procedure? How do I select the missed approach holding point?

The 400W-series unit does not automatically sequence past the MAP. Waypoint sequencing to the first waypoint in the missed approach procedure will be enabled when the **OBS** key is pressed after crossing the MAP. All published missed approach procedures must be followed, as indicated on the approach plate.

To execute the missed approach procedure prior to the MAP (not recommended), select the active flight plan page and use the **direct-to** key (by pressing it twice) to activate the missed approach portion of the procedure.

How do I re-select the same approach or activate a new approach after a missed approach?

After flying all missed approach procedures, you may reactivate the same approach for another attempt from the *procedures page*. Once you have been given clearance for another attempt, activate the approach from the *procedures page* by highlighting “Activate Approach?” and then pressing **ENT**. The 400W-series unit will provide navigation along the desired course to the waypoint and rejoin the approach in sequence from that point on. See *Section 4 - Active Flight Plan Leg Selection* for information on activating a specific flight plan leg.

To activate a new approach for the same airport, select the new procedure from the *procedures page*. To view the *procedures page*, press **PROC** and turn the **large right** knob to highlight “Select Approach?”. Press **ENT** and turn the **large right** knob to highlight the new approach you want to fly. Press **ENT** to select the approach, then select the desired transition. Finally, highlight “Activate?” at the bottom right corner of the screen and press **ENT** to activate the new approach.

To activate a new approach to a different airport, press **direct-to** and select the desired airport using the **small** and **large right** knobs. Press **ENT** to accept the selected airport, then follow the steps in the preceding paragraph to select an approach for the new airport. See *Section 4 - Flight Plan Options* for more information on selecting and activating approaches.



NOTE: Do not attempt to reactivate the same approach you're currently on, prior to crossing the missed approach point (MAP). If you attempt to do so, an alert message (“Are you sure you want to discontinue the current approach?”) appears. If you still proceed with reactivating the approach, the 400W-series unit directs you back to the transition waypoint and does NOT take into consideration any missed approach procedures.

Index

Symbols

3D navigation 8, 56

A

Abbreviations 120, 122, 123, 129, 130, 131, 181, 189

Accessories iii

Acquiring satellites 8, 55

Activate flight plan 22, 68

Active flight plan 21, 67, 70, 72, 76, 77, 79, 83, 125, 134,
155, 159, 160

Active leg 13, 30, 72, 77, 93, 98, 188, 200

Airport

Approach 117, 120, 124, 125, 197

Arrival 126

Departure 127

Frequency 122

Runway 121

Airspace 36, 144, 181, 185

Alarm 170, 172

Alert 20, 138, 145, 146, 147, 173

Frequencies 36

Alarms 170, 171, 173

Alerts

Terrain 46

ALT 193

Altitude i, 14, 20, 31, 40, 42, 44, 52, 55, 56, 72, 89, 93, 97,
100, 101, 108, 110, 122, 123, 145, 147, 153, 154,
155, 158, 159, 170, 172, 174, 181, 185, 193, 196

Altitude buffer 147, 170, 172

Altitude input 102, 185

Annunciations 46, 59, 85, 124, 188

Approach 17, 74, 78, 83, 181, 186, 197, 200

Activate 84

Airport 124

DME arc 94

Hold 91

ILS 104

Localizer 114

LPV 109

Procedure turn 86

VTF 84, 97

Approach Channel 126

ARINC 185, 196

Arrival 17, 51, 75, 78, 83, 126, 173, 181, 200

ARTCC 18, 26, 137, 138, 142, 143, 189

Auto-tuning 24, 25, 150

Automatic CDI switching 114

Automatic operation 159

Autopilot 96, 105, 113, 114, 115, 200

Auto zoom 34, 38

Aux pages 153

Flight planning 154

Setup 1 170

Setup 2 176

Utility 163

Aviation data 43

B

Backcourse 114

Backlight 177, 178, 182, 183

Bank angle 186, 200

Barometric pressure 155, 158, 174

Basemap 182, 185

Basic approach operation 85

C

Catalog 11, 21, 67, 68

Cautions i, 46, 48, 146

CDI 4, 61, 114, 152, 171, 173, 182, 199, 200

Ceiling 20, 36, 145, 146

Channel spacing 176, 177

Checklists 7, 164, 165

City 37, 62, 129, 130

Clear 3

CLR 3

Com 2, 9, 182, 196

Configuration 177

Squelch 23

Tuning 24

Volume 23

Window 24

Comment 68, 71

Controlled airspace 20, 33, 36, 137, 138, 145

Count down timer 187

Course from 100

Course from fix to altitude 101
Course from fix to distance 100
Course from fix to DME distance 100
Course from fix to manual sequence 103
Create flight plan 21
Creating user waypoints 131
Crossfill 73, 159
Cross-side 161
Crossfill 70, 135, 155, 159, 183
CRSR 3, 189
CTAF 123, 139, 140, 189
Cursor 3

D

Database i, iii, 32, 41, 45, 46, 49, 84, 125, 159, 160, 162, 163, 195, 198
Data base integrity error 186, 187
Database version 45, 165, 169
Data base integrity error 181, 182
Data fields 13, 14, 30, 32, 34, 37, 40, 52, 72, 156
Data transfer 159, 183
Date 161, 168, 169, 172, 175
Dead reckoning 59, 185
Declutter 14, 34
Default Nav page 13, 16, 30
Density altitude 155, 158
Departure 17, 51, 75, 78, 83, 127, 200
Departure time 158, 164, 167
DG heading 200
Direct-To 3, 16, 36, 61
 Cancelling 65
 Flight plan destination 63
 Manual course 65
 Nearest airport 63
 Shortcuts 64
Display backlight 177, 178
Distance measurements 39
DME Arc 94
Dual units 32
Duplicate waypoint 119

E

E6B 153, 154
EFF 156, 189, 193

EFIS 133
Emergency channel 2, 27
ENDUR 156, 189
ENR 85
ENT 3
Enter 3
Environmental 196
En route 51
EPU 56, 189, 193

F

Facility name 62, 118, 119, 120, 129, 130, 142, 143
Factory settings 32, 41, 54, 176
FDE 56, 180
FIR 18, 137, 189
Flight plan 4, 21, 67, 154
 Activate 22, 68
 Active 72
 Catalog 21, 67, 68
 Copy 70
 Create 21, 69
 Delete 70
 Editing 67
 Invert 69
 Shortcuts 78
Flight timers 164, 166
Flip-flop key 2
Floor 20, 36, 145, 146
Foreword ii
FPL 4
Frequency 122
Frequency list 15, 26, 51, 122
FSS 26, 137, 138, 143
Fuel flow 6
Fuel on board 6
Fuel planning 154

G

GAD 184
Geodesic 193
Glideslope 24, 149, 183, 196
GNC 420W/AW 1
GNS 430W/AW 1
GPS 184, 196

GPS 400W 1
 Great circle 193
 GTN Crossfill 162

H

HFOM 56
 Hold 91, 188
 HSI 61, 152, 198

I

Ident audio and volume 149
 IFR 17
 IFR procedures 17
 ILS 104, 173
 ILS CDI Selection 105, 114, 171, 173
 Inhibit terrain 43
 Inside airspace 20
 Instrument panel self-test 6
 Integ 8, 164, 190, 197
 Interfaces 196
 Intersection 129, 141

J

Jeppesen 195

K

Key descriptions 2
 Key stuck 182
 King autopilot 115
 Knob descriptions 2

L

LFOB 156
 LNAV/VNAV Approach 85, 110, 112
 Localizer 149, 196
 Localizer Approach 114
 Low alt 85
 LPV Approach 85, 109
 LRES 156

M

Magnetic variation 172, 174
 Map
 Auto zoom 34
 Create user waypoint 133

Data fields 40
 Datum 172, 175
 Page 14, 32
 Panning 35
 Scale 33, 121
 Setup 37
 Symbols 33
 MAPR 85
 Measure dist? 39
 Menu 3
 Messages 4, 8, 181
 Minimum safe altitude 52, 194
 Missed approach 90, 202
 Model descriptions 1
 MSA 52, 194
 MSG 4

N

Navcom 15, 51
 NavData Card 195
 Navigation database 46
 Navigation Terms 193
 Nav pages 12, 29
 On-screen data 31
 NDB 129, 141
 Nearest 4, 18, 137
 Airport 177, 179
 Airspace 20, 144
 ARTCC 142
 FSS 143
 Intersection 141
 Navigate to 139
 NDB 141
 User waypoint 142
 VOR 141
 Next FPL airport 120, 122, 124, 126, 127, 128
 NRST 4

O

OBS 4, 186, 198
 OCN 85
 Odometer 168

P

Packing list iii
Page groups 10, 29
Panning 35
Parallel track 77
PDA 48
Position 52, 172, 175
Power on 5
Power up 5
Premature descent alerting 48
Preset Com frequency 177
PROC 4
Procedures 4, 17
Procedure turn 86
PTT 182

R

Railroads 37
RAIM 164, 168, 197
Range 3
Reference waypoint 53, 131
Remote frequency control 28, 177
REQ 156
Reset all 168
Reset max speed 167
Reset odometer 168
Reset trip 167
Restore defaults 78
Restoring factory settings 32, 54, 176
Rivers and Lakes 37
RNG 156
Roll steering 113
Runway 121, 179

S

Satellite status 55
SBAS 179
Scheduler 155, 161, 186
Searching sky 8, 55
Select frequency 9, 15
Self-test 6
Setup page 170, 176
SIDs 17, 127
Slant golf 198

Software version 164, 169
Sort list 71
Special use airspace 20
Specifications 196
Squelch 23
Standard package iii
Standby frequency 9
STARs 17, 75, 126
Stormscope 186
Stuck microphone 27
Sunrise/sunset 164, 169
Symbols 44

T

Takeoff tour 1
Target altitude 181
TAS 155, 158
TERM 85
Terminology 181
Terrain 41
 Alerts 50
 Symbols 44
Time 8, 52, 172, 175
Timer 187
Traffic 40, 187
Transitions 124
Trip planning 154
Trip statistics 167
Troubleshooting 197
Turn anticipation 200

U

Units of measure 172, 174
User comment 68
User waypoint 131
UTC 172, 175
Utility 163

V

Vectors to Final 74, 84, 97
Vertical navigation 56
Vertical speed 58, 174
VFOM 56
VHF com 196

VLOC 2, 9, 114, 149, 186, 187
 Ident audio 149
 Tuning 149
VNAV 56, 181
Volume 23
VOR 130, 141, 149, 196
VSR 58, 194

W

WAAS approach ID 126
Warranty iv
Waypoint 117, 200
 Airport 120
 Airport frequency 122
 Airport runway 121
 Approach 124
 Arrival 126
 City 118
 Departure 127
 Duplicate 119
 Facility 118
 Identifier 118
 Intersection 129
 Modify user 133
 NDB 129
 User 131, 142
 VOR 130
WGS 84 172
Winds 155, 158
Wind vector 37, 39
Wx broadcast 130

Blank Page



© 2016 Garmin Corporation

Garmin International, Inc.
1200 East 151st Street, Olathe, Kansas 66062, U.S.A.
Tel. 913/397.8200 or 800/800.1020
Fax 913/397.8282

Garmin AT, Inc.
2345 Turner Rd., S.E., Salem, Oregon 97302, U.S.A.
Tel. 503/581.8101 or 800/525.6726
Fax. 503/364.2138

Garmin (Europe) Ltd.
Liberty House, Bulls Copse Road, Hounslow Business Park,
Southampton, SO40 9RB, U.K.
Tel. +44 (0) 37 0850 1243
Fax +44 (0) 23 8052 4004

Garmin Singapore Pte. Ltd.
46 East Coast Road
#05-06 Eastgate
Singapore 428766
Tel. (65) 63480378
Fax (65) 63480278

www.garmin.com
<https://fly.garmin.com/fly-garmin>

Part Number 190-00356-00 Rev K